

NORMBAU

PASSION FOR CARE

Eco Care



Preisliste 2023 · Price list 2023



ALLEGION



A modern bathroom with a white sink, mirror, and shelves against a blue mosaic wall. The sink is a white, rectangular, wall-mounted unit with a chrome faucet. Above the sink is a large, rectangular mirror with a silver frame. To the left of the sink is a white paper towel dispenser. To the right is a white soap dish with a toothbrush. On the far right, there are three white shelves holding various toiletries. A grey shower curtain is on the left, and a towel hangs on a rack on the right. The wall is covered in small, square, blue mosaic tiles. The floor is made of light-colored wood planks.

Eco Care

Sicherheit & Qualität

Mit Eco Care lassen sich Badezimmer innerhalb kürzester Zeit individuell an die Bedürfnisse von Menschen mit eingeschränkter Mobilität anpassen. Die aus weißem pulverbeschichtetem Edelstahl hergestellte Serie ist nicht nur preiswert, sondern überzeugt auch mit einer hohen Widerstandsfähigkeit.

Safety & Quality

With Eco Care, bathrooms can be adapted quickly and individually to the needs of people with limited mobility. The series made of white powder-coated stainless steel is not only inexpensive, but also impresses with its high resistance.

- + Mit antibakteriellem Schutz: Antibac
With antibacterial protection: Antibac



Was ist Antibac?

Produkte von Eco Care und Produktlinien mit dem Zusatz Antibac werden in der Herstellung mit einem antibakteriellen Wirkstoff (Antibac) ausgestattet (S. 6 - 7).

What is antibacterial protection?

Antibac is built-in to Eco Care products in scratch-resistant powder coating and to solid products during manufacture to provide an extra level of hygiene (p. 6 - 7).

- + 5 Jahre Gewährleistung auf Funktion und Stabilität
5 years warranty on function and stability

- + Einfache Montage durch Steckverbindung und besserer Toleranzausgleich bei gleicher Belastbarkeit
Easy assembly by means of a plug-in connection, including a better tolerance compensation with the same load capacity.



Was Eco Care auszeichnet: What characterises Eco Care:

- + Sicherheit durch abgerundete Außenkanten
Safety by rounded outer edges



- + Softabsenkung der Stützklappgriffe ohne Demontage der Produktteile einfach einstellbar

The soft close of the Lift up support can be adjusted without dismantling the lift up rail

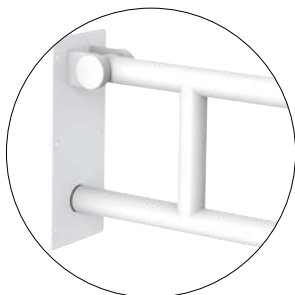

- + Die ergonomische Form bietet jederzeit einen sicheren Griff
The ergonomic shape offers a secure grip at all times

- + Auf hohe Belastbarkeit getestet und geprüft
Tested and checked for high load capacity

- + Homogene Oberfläche zur optimalen Reinigung und perfekten Hygiene
Homogeneous surface for ideal cleaning and hygiene

- + Schnelle und sichere Montage
Fast and safe assembly

- + Attraktives Preis-Leistungsverhältnis
Attractive price-performance ratio

- + Kombinierbar mit den Accessoires aller NORMBAU Serien
Combinable with accessories of all NORMBAU series

- + Hohe Qualität durch pulverbeschichtetes Edelstahlrohr
High quality, thanks to powder-coated stainless steel tube

- + Nylon-Rosettenunterlagen zur schonenden Wandauflage und Abdeckung der Verschraubung

Nylon rosette pads for gentle wall support and screw connection cover

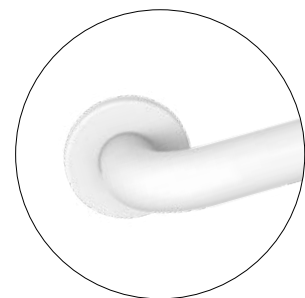

- + Optionale Dichtringe ermöglichen die normgerechte Abdichtung der Bohrpunkte (DIN 18534-1)

Round blanks are available for sealing of the drilling points according to German standard (DIN 18534-1)



NEU
NEW



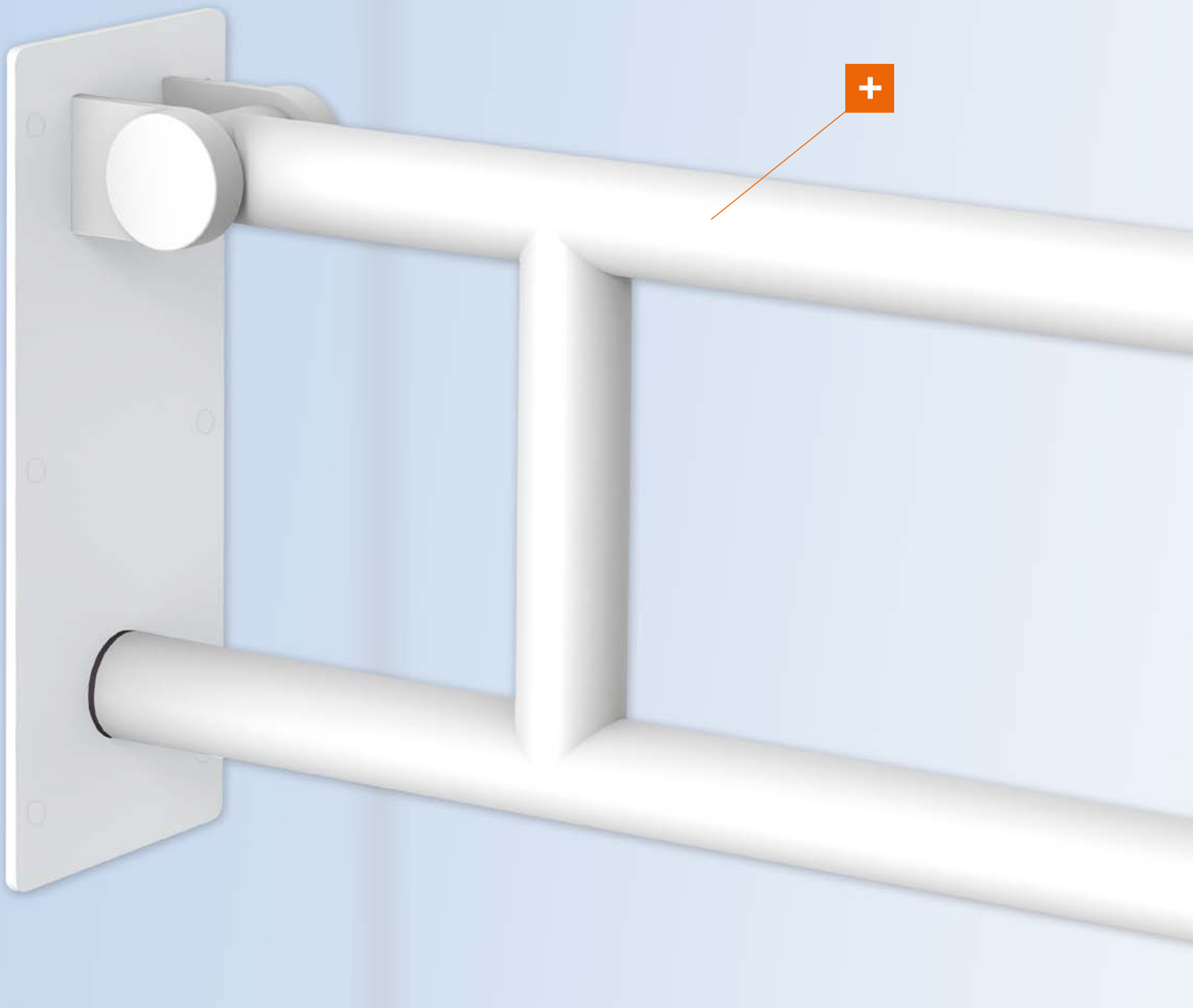

Nachhaltigkeit als Beitrag zum Umweltschutz

- Ressourcenschonende Applikationstechnologie
- Längere Lebensdauer
- Einsparung von Wasser, Reinigungsmitteln und Energie
- Einhaltung internationaler Vorschriften und Standards
- Zertifizierte Sicherheit für Mensch und Umwelt

Sustainable contribution protecting the environment

- Resource-friendly application technology
- Longer life cycle
- More economical use of water, cleaning agents and energy
- Compliant with international regulations and standards
- Certified safety for people and the environment

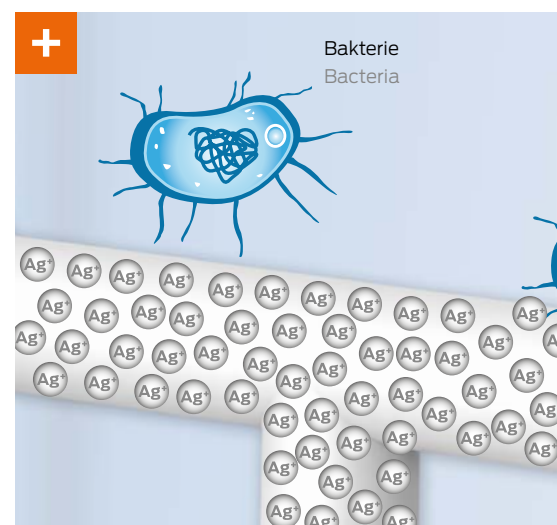

Antibakterieller Hygieneschutz

Antibacterial hygiene protection

Produktvorteile

- Breites Wirkungsspektrum gegen Bakterien und Pilze
- Langanhaltende Schutzwirkung durch kontrollierte Silberionen-Freigabe
- Keine Nanotechnologie
- Sehr hohe Reinigungs-, Nutzungs- und Lichtstabilität
- Keine Verfärbung oder Vergilbung
- Umweltfreundlich
- Ausgezeichnete Hautverträglichkeit
- Qualitativ hochwertiges und innovatives Produkt



Product benefits

- Outstanding resistance against bacteria and fungi
- Long lasting protection by controlled release of silver ions
- No nanotechnology
- Very high resilience to cleaning, usage and light
- No discolouration or yellowing
- Environmentally friendly
- Exceptional skin tolerance
- Innovative, premium quality product

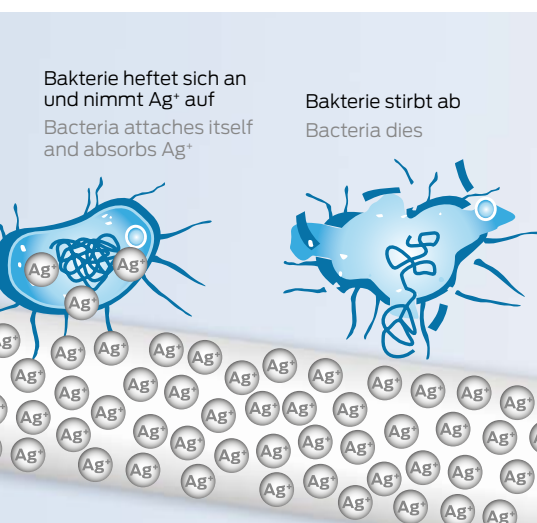

Antibac bringt Sicherheit

NORMBAU baut auf die Ressourcenschonende Applikationstechnologie von Antibac mit Silberionen. Das Masterbatch wird mit dem Pulverlack vermischt und im Beschichtungsvorgang gleichmäßig auf das Produkt aufgetragen. Die so antibakteriell geschützte Oberfläche sorgt für eine erhöhte Sicherheit, das Wachstum von schädlichen Mikro-Organismen, wie Bakterien und Schimmel, wird verhindert.

Antibac for safety

NORMBAU uses silver ions to enhance the resource-saving application technology of Antibac. The master batch is mixed into the powder coating and evenly applied to the product during the coating process. Protecting the surface against bacteria in this way ensures increased safety by preventing the growth of harmful micro-organisms such as bacteria and mould.



Preisliste | Price list 2023

Eco Care



Produktführer
Product guide

11



Bereich WC
Toilet area

12 - 16



Bereich Dusche
Shower area

17 - 23

Nylon Care

Accessoires
Accessories

24 - 48



Bereich WC / Toilet area



Stützklappgriff
Lift-up supports

Seiten / Pages 12 - 13



Stützklappgriff
Lift-up supports

Seiten / Pages 14 - 15



Winkelgriff 135°
Grab rails 135°

Seiten / Pages 16 - 17

Bereich Dusche / Shower area



Haltegriff
Grab bars

Seite / Page 17



Duschhandlauf
Shower handrails

Seite / Page 18



Brausehalterstange
Shower head rails

Seite / Page 20



Duschhandlauf mit Brausehalterstange
Shower handrails with shower head rail

Seite / Page 19

NEW



Duschklappsitze
Shower seats

Seiten / Pages 20 - 21

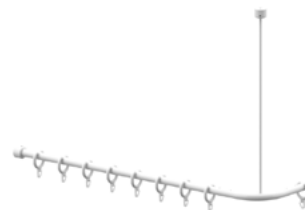

Duschvorhang/-stangen
Shower curtain rails

Seiten / Pages 22 - 23





Stützklappgriff

- Länge 600, 725, 850 und 900 mm, Ø 32 mm,
- aus Edelstahl mit Pulverbeschichtung, Farbe weiß (019), mit antibakteriellem Schutz,
- links und rechts einsetzbar,
- Ausladung hochgeklappt 216 mm,
- mit einstellbarer Bremse,
- mit Kappen zur verdeckten Verschraubung,
- Befestigungsplatte aus Edelstahl 100 x 250 mm,
- max. zul. Belastung: 100 kg,
- nachrüstbar mit Bodenstütze 1449220 / 1449221 / 1449222, empfohlen für Stützklappgriffe ab Länge 850 mm.

Lift-up support rail

- length 600, 725, 850, 900mm, 32mm dia.,
- made of stainless steel with powder coating, colour white (019), with antibacterial protection,
- left and right hand application,
- space required in vertical position 216mm from wall,
- with maintenance-free brake,
- with screw caps for concealed fixing,
- mounting plate made of stainless steel 100 x 250mm,
- maximum loading permitted: 100kgs,
- retrofitting with floor support 1449220 / 1449221 / 1449222, recommended for Lift-up support rails from length 850 mm.

Stützklappgriff Code PG 3700
Lift-up support rail

▶ L = 600 mm	1447 260	204,00 €
▶ L = 725 mm	1447 270	217,00 €
▶ L = 850 mm	1447 280	229,00 €
▶ L = 900 mm	1447 290	242,00 €

ⓘ Das Montageset muss separat bestellt werden.

ⓘ The fixing set should be ordered separately.

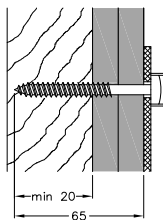
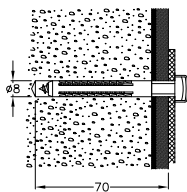
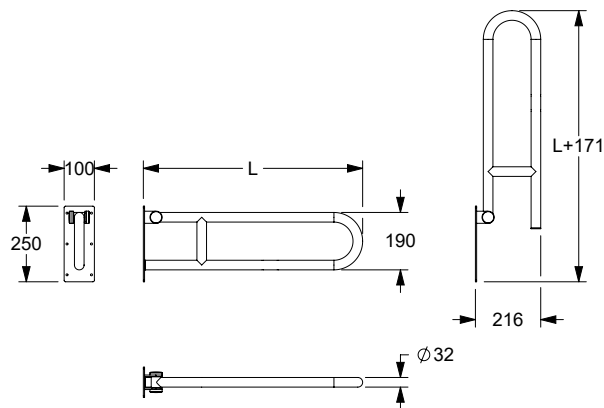

Montageset

- **für Mauerwerk aus Vollstein:** Beton ≥ B15, Vollziegel ≥ Mz 12, Kalksand-Vollstein ≥ KS 12, Naturstein mit dichtem Gefüge,
- **für Vorwandinstallationen** mit integrierter Befestigungsplatte aus mehrschichtverleimtem Holz als Hinterfütterung,
- **für Leichtbauwände** aus Gipskarton, Spanplatten, Hartfaserplatten, mit einer Hinterfütterung aus mind. 20 mm dickem mehrschichtverleimtem Holz,
- bestehend aus:
6 Dübel MQ 8 x 40 mm,
6 Torx Schrauben Ø 6 x 70 mm, aus Edelstahl A2-AISI 304,
6 Abdeckkappen.

Fixing set

- **brickwork made of full brick** concrete ≥ B15, solid brick ≥ Mz 12, sand-lime brick-solid brick ≥ KS 12, natural stone with compact grain,
- **behind the wall with panels** and integrated mounting plate made of timber,
- **lightweight partition walls**, made of gypsum, flake board and hardboard with backfill, made of min. 20mm hardwood,
- composed of:
6 plugs MQ 8 x 40mm,
6 screws 6 x 70mm dia. (Torx T40), made of stainless steel A2-AISI 304,
6 screw caps.

Code PG 3700

▶ Montageset Fixing set	1470 440	11,50 €
----------------------------	-----------------	---------





Papierrollenhalter, nachrüstbar

- 163 x 94 x 20 mm,
- aus Nylon, Farbe weiß (019), mit antibakteriellem Schutz,
- mit selbsteinstellender und wartungsfreier Abrollbremse,
- verdeckte Verschraubung.

Paper roll holder, can be added at a later stage

- 163 x 94 x 20mm,
- made of nylon (PA), colour white (019), with antibacterial protection,
- with self-adjusting and maintenance-free roller brake,
- concealed screw fixing.

Papierrollenhalter, nachrüstbar Paper roll holder, can be added at a later stage

Code PG 3700

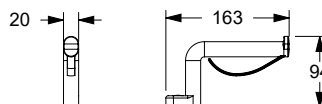

▶ 163 x 94 x 20 mm **1449 210** 18,25 €

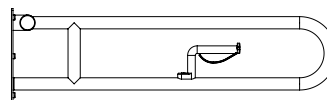

Bodenstütze, nachrüstbar

- für Montage an Stützklappgriffen der Eco Care Serie,
- 566 mm für Befestigungshöhe 750 mm, 616 mm für Befestigungshöhe 800 mm, 666 mm für Befestigungshöhe 850 mm, Ø 34 mm
- aus Nylon, Farbe weiß (019), mit antibakteriellem Schutz, Puffer aus Kunststoff in schwarz,
- Höhe +/- 8 mm einstellbar,
- Stützklappgriff mit Bodenstütze getestet bis 200 kg, empfohlene max. Belastung: 135 kg,
- arretiert automatisch im heruntergeklappten Zustand.

Floor support, can be added at a later stage

- for lift-up support (Eco Care series),
- 566mm for fixing height 750mm, 616mm for fixing height 800mm, 666mm for fixing height 850mm, 34mm dia.,
- made of nylon, colour white (019), with antibacterial protection, buffer made of plastic in black,
- height +/- 8 mm adjustable,
- lift-up support with floor support tested up to 200kgs, recommended maximum loading: 135kgs,
- locked in in fold-down position.

Bodenstütze Floor support

Code PG 3700

▶ 566 mm **1449 220** 66,50 €
für Befestigungshöhe 750 mm
for fixing height 750mm

▶ 616 mm **1449 221** 70,50 €
für Befestigungshöhe 800 mm
for fixing height 800 mm

▶ 666 mm **1449 222** 74,50 €
für Befestigungshöhe 850 mm
for fixing height 850mm

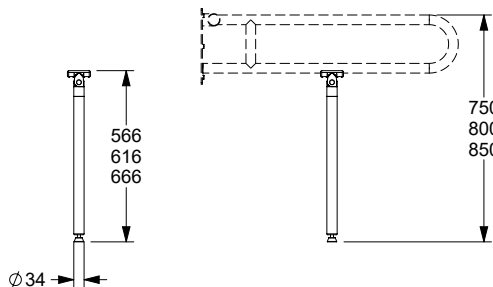



Stützklappgriff

- Länge 600, 725 und 850 mm, Ø 32 mm,
- aus Edelstahl, Werkstoff Nr. 1.4301 (A2, AISI 304), Oberfläche fein matt,
- links und rechts einsetzbar,
- Ausladung hochgeklappt 216 mm,
- mit einstellbarer Bremse,
- mit Kappen zur verdeckten Verschraubung,
- Befestigungsplatte aus Edelstahl 100 x 250 mm,
- max. zul. Belastung: 100 kg,
- nachrüstbar mit Bodenstütze 1449331 / 1449332 / 1449333, empfohlen für Stützklappgriffe ab Länge 850 mm.

Lift-up support rail

- length 600, 725, 850mm, 32mm dia.,
- made of stainless steel, material No. 1.4301 (A2, AISI 304), brushed finish,
- left and right hand application,
- space required in vertical position 216mm from wall,
- with maintenance-free brake,
- with screw caps for concealed fixing,
- mounting plate made of stainless steel 100 x 250mm,
- maximum loading permitted: 100kgs,
- retrofitting with floor support 1449331 / 1449332 / 1449333, recommended for Lift-up support rails from length 850 mm.

Stützklappgriff Lift-up support rail

Code PG 3700

▶ L= 600 mm	1447 016	204,00 €
▶ L= 725 mm	1447 017	217,00 €
▶ L= 850 mm	1447 018	229,00 €

① Das Montageset muss separat bestellt werden.

① The fixing set should be ordered separately.

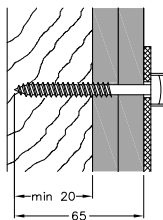
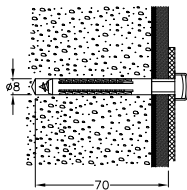
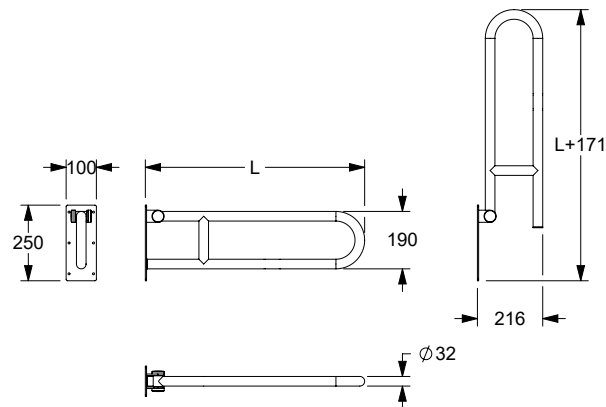

Montageset

- **für Mauerwerk aus Vollstein:**
Beton ≥ B15,
Vollziegel ≥ Mz 12,
Kalksand-Vollstein ≥ KS 12,
Naturstein mit dichtem Gefüge,
- **für Vorwandinstallationen** mit integrierter Befestigungsplatte aus mehrschichtverleimtem Holz als Hinterfütterung,
- **für Leichtbauwände** aus Gipskarton, Spanplatten, Hartfaserplatten, mit einer Hinterfütterung aus mind. 20 mm dickem mehrschichtverleimtem Holz,
- bestehend aus:
6 Dübel MQ 8 x 40 mm,
6 Torx Schrauben Ø 6 x 70 mm,
aus Edelstahl A2-AISI 304,
6 Abdeckkappen.

Fixing set

- **brickwork made of full brick**
concrete ≥ B15,
solid brick ≥ Mz 12,
sand-lime brick-solid brick ≥ KS 12,
natural stone with compact grain,
- **behind the wall with panels** and integrated mounting plate made of timber,
- **lightweight partition walls**, made of gypsum, flake board and hardboard with backfill, made of min. 20mm hardwood,
- composed of:
6 plugs MQ 8 x 40mm,
6 screws 6 x 70mm dia. (Torx T40),
made of stainless steel A2-AISI 304,
6 screw caps.

Code PG 3700

▶ Montageset Fixing set	1470 550	11,50 €
----------------------------	-----------------	---------





Papierrollenhalter, nachrüstbar

- 163 x 94 x 20 mm,
- aus Nylon, Farbe dunkelgrau (018), mit antibakteriellem Schutz,
- mit selbsteinstellender und wartungsfreier Abrollbremse,
- verdeckte Verschraubung.

Paper roll holder, can be added at a later stage

- 163 x 94 x 20mm,
- made of nylon, colour dark grey (018), with antibacterial protection,
- with self-adjusting and maintenance-free roller brake,
- concealed screw fixing.

Papierrollenhalter, nachrüstbar Paper roll holder, can be added at a later stage

Code PG 3700

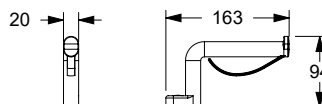

▶ 163 x 94 x 20 mm **1449 210** 18,25 €

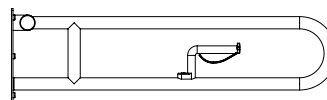

Bodenstütze, nachrüstbar

- für Montage an Stützklaappgriffen der Eco Care Serie,
- 566 mm für Befestigungshöhe 750 mm, 616 mm für Befestigungshöhe 800 mm, 666 mm für Befestigungshöhe 850 mm, Ø 32 mm
- Gelenk aus Nylon, Farbe dunkelgrau (018), Bodenstütze aus Edelstahl, Werkstoff Nr. 1.4301 (A2, AISI 304), Oberfläche fein matt, Puffer aus Kunststoff in schwarz,
- Höhe +/- 8 mm einstellbar,
- Stützklaappgriff mit Bodenstütze getestet bis 200 kg, empfohlene max. Belastung: 135 kg,
- arretiert automatisch im heruntergeklappten Zustand.

Floor support, can be added at a later stage

- for lift-up support (Eco Care series),
- 566mm for fixing height 750mm, 616mm for fixing height 800mm, 666mm for fixing height 850mm, 32mm dia.,
- joint made of nylon, colour dark grey (018), floor support made of stainless steel, material No. 1.4301 (A2, AISI 304), brushed finish, buffer made of plastic in black,
- height +/- 8 mm adjustable,
- lift-up support with floor support tested up to 200kgs, recommended maximum loading: 135kgs,
- locked in in fold-down position.



Bodenstütze Floor support

Code PG 3700

▶ 566 mm **1449 331** 67,50 €
für Befestigungshöhe 750 mm
for fixing height 750mm

▶ 616 mm **1449 332** 73,50 €
für Befestigungshöhe 800 mm
for fixing height 800mm

▶ 666 mm **1449 333** 79,50 €
für Befestigungshöhe 850 mm
for fixing height 850mm

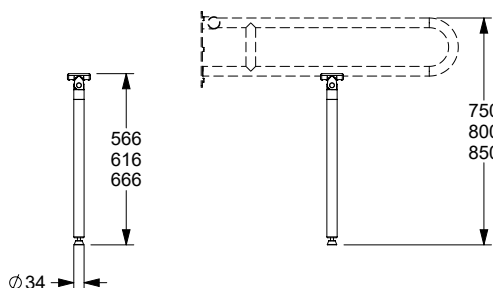



NEW

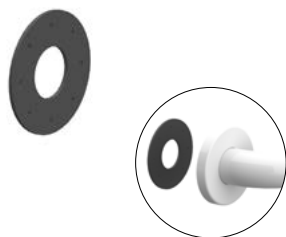

Dichtronde

- Ø 62 mm,
- selbstklebend, mit Trägerfolie,
- aus Zellkautschuk EPDM, Farbe schwarz,
- ermöglicht die normgerechte Abdichtung der Bohrpunkte (DIN 18534-1),
- auch auf Fugen einsetzbar,
- für alle Eco Care Produkte mit Rosette Ø 70 mm einsetzbar,
- Verpackungseinheit 10 bzw. 50 Stück.

Round blank

- Ø 62mm,
- self-adhesive, with carrier foil,
- made of cell rubber EPDM, colour black,
- sealing of the drilling points according to German standard DIN 18534-1 possible,
- can also be used on seams,
- can be used with all Eco Care products with Ø 70mm rose,
- packing units of 10 pcs respectively 50 pcs.

Dichtronde Round blank

Code PG 5500

▶ 62 x 2 mm
10 Stück
10 pieces

2053 601 16,75 €

▶ 62 x 2 mm
50 Stück
50 pieces

2053 610 58,50 €

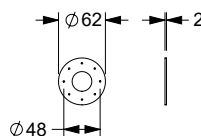

Winkelgriff, 135°

- 135°, 400 x 400 mm, Ø 32 mm, mit zwei Befestigungspunkten, links und rechts einsetzbar,
- aus Edelstahl mit Pulverbeschichtung, Farbe weiß (019), mit antibakteriellem Schutz,
- mit Rosetten Ø 70 mm zur verdeckten Verschraubung,
- Rosettenunterlage aus Nylon zur schonenden Wandauflage,
- max. zul. Belastung: 125 kg,
- Lieferung mit Edelstahl Torx-Schrauben Ø 6 x 70 mm und Dübeln für Vollbaustoffe und Wände mit Hinterfüllung aus Holz.

Grab rail, 135°

- 135°, 400 x 400mm, 32mm dia., with two fixing points, left or right hand applicable,
- made of stainless steel with powder coating, colour white (019), with antibacterial protection,
- with roses 70mm dia. for concealed screw fixing,
- rose inner made of Nylon in order to protect the wall,
- maximum loading permitted: 125kgs,
- supplied with 6mm dia. x 70mm stainless Torx screws and plugs for solid masonry and walls with backfill made of wood.

❗ Für den Einsatz von Dichtronden 2053 601/2053 610 geeignet.

❗ For the use of round blanks 2053 601/2053 610.

Winkelgriff 135° Grab rail 135°

Code PG 3700

▶ 400 x 400 mm
mit zwei Befestigungspunkten
with two fixing points

1464 320 69,50 €

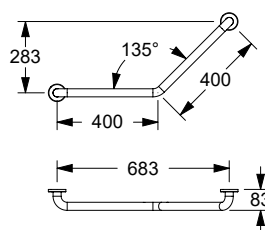

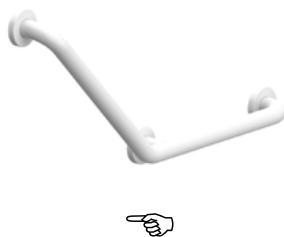

Winkelgriff, 135°

- 135°, 400 x 400 mm, Ø 32 mm, mit drei Befestigungspunkten, linke und rechte Ausführung,
- aus Edelstahl mit Pulverbeschichtung, Farbe weiß (019), mit antibakteriellem Schutz,
- mit Rosetten Ø 70 mm zur verdeckten Verschraubung,
- Rosettenunterlage aus Nylon zur schonenden Wandauflage,
- max. zul. Belastung: 175 kg,
- Lieferung mit Edelstahl Torx-Schrauben Ø 6 x 70 mm und Dübeln für Vollbaustoffe und Wände mit Hinterfüterung aus Holz.

❗ Für den Einsatz von Dichtronden 2053 601/2053 610 geeignet.

Grab rail, 135°

- 135°, 400 x 400mm, 32mm dia., with three fixing points, left or right hand available,
- made of stainless steel with powder coating, colour white (019), with antibacterial protection,
- with roses 70mm dia. for concealed screw fixing,
- rose inner made of Nylon in order to protect the wall,
- maximum loading permitted: 175kgs,
- supplied with 6mm dia. x 70mm stainless Torx screws and plugs for solid masonry and walls with backfill made of wood.

❗ For the use of round blanks 2053 601/2053 610.

Winkelgriff 135° Grab rail 135°	Code	PG 3700
▶ 400 x 400 mm mit drei Befestigungspunkten with three fixing points	1464 330	85,00 €
▶ 400 x 400 mm mit drei Befestigungspunkten with three fixing points	1464 331	85,00 €

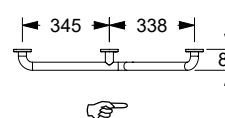
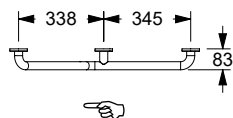
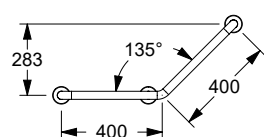
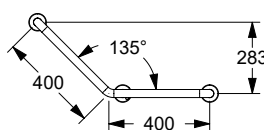

Haltegriff

- Achsmaß (a) 300, 400, 500 und 600 mm, Ø 32 mm,
- aus Edelstahl mit Pulverbeschichtung, Farbe weiß (019), mit antibakteriellem Schutz,
- mit Rosetten Ø 70 mm zur verdeckten Verschraubung,
- Rosettenunterlage aus Nylon zur schonenden Wandauflage,
- max. zul. Belastung: 175 kg,
- Lieferung mit Edelstahl Torx-Schrauben Ø 6 x 70 mm und Dübeln für Vollbaustoffe und Wände mit Hinterfüterung aus Holz.

❗ Für den Einsatz von Dichtronden 2053 601/2053 610 geeignet.

Grab bar

- axial dimensions (a) 300, 400, 500 or 600mm, 32mm dia.,
- made of stainless steel with powder coating, colour white (019), with antibacterial protection,
- with roses 70mm dia. for concealed screw fixing,
- rose inner made of Nylon in order to protect the wall,
- maximum loading permitted: 175kgs,
- supplied with 6mm dia. x 70mm stainless Torx screws and plugs for solid masonry and walls with backfill made of wood.

❗ For the use of round blanks 2053 601/2053 610.

Haltegriff Grab bar	Code	PG 3700
▶ a = 300 mm	1453 230	41,00 €
▶ a = 400 mm	1453 240	47,00 €
▶ a = 500 mm	1453 250	53,00 €
▶ a = 600 mm	1453 260	59,50 €

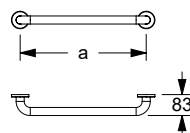



Duschhandlauf

- 750 x 420 mm, Ø 32 mm,
- links und rechts einsetzbar,
- aus Edelstahl mit Pulverbeschichtung, Farbe weiß (019), mit antibakteriellem Schutz,
- mit Rosetten Ø 70 mm zur verdeckten Verschraubung,
- Rosettenunterlage aus Nylon zur schonenden Wandauflage,
- max. zul. Belastung: 175 kg,
- Lieferung mit Edelstahl Torx-Schrauben Ø 6 x 70 mm und Dübeln für Vollbaustoffe und Wände mit Hinterfüterung aus Holz,
- geeignet für NORMBAU Einhängesitze.

📌 Für den Einsatz von Dichtringen 2053 601/2053 610 geeignet.

Shower handrail

- 750 x 420mm, 32mm dia.,
- left and right hand application,
- made of stainless steel with powder coating, colour white (019), with antibacterial protection,
- with roses 70mm dia. for concealed screw fixing,
- rose inner made of Nylon in order to protect the wall,
- maximum loading permitted: 175kgs,
- supplied with 6mm dia. x 70mm stainless Torx screws and plugs for solid masonry and walls with backfill made of wood,
- suitable for NORMBAU suspendable shower seats.

📌 For the use of round blanks 2053 601/2053 610.

Duschhandlauf Shower handrail	Code	PG 3700
▶ 750 x 420 mm	1484 342	145,00 €

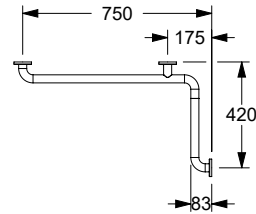

Winkelgriff mit Brausehalter

- 480 x 1200 mm, Ø 32 mm,
- linke und rechte Ausführung,
- max. zul. Belastung: 175 kg,
- weitere Beschreibung wie oben,
- geeignet für NORMBAU Einhängesitze.

Grab rail with shower head holder

- 480 x 1200 mm, 32mm dia.,
- left or right hand applicable,
- maximum loading permitted: 175kg,
- further description see above,
- suitable for NORMBAU suspendable shower seats.

Winkelgriff mit Brausehalter Grab rail with shower head holder	Code	PG 3700
▶ 480 x 1200 mm 👉	1465 348	175,00 €
▶ 480 x 1200 mm 👈	1465 349	175,00 €

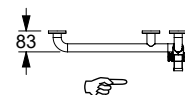
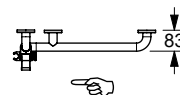
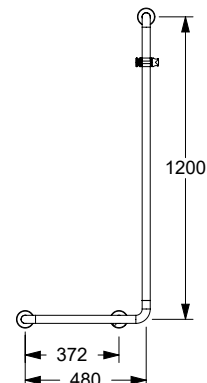
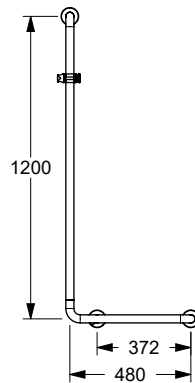



Duschhandlauf mit Brausehalterstange

- 500 x 1200 mm, Ø 32 mm,
- aus Edelstahl mit Pulverbeschichtung, Farbe weiß (019), mit antibakteriellem Schutz,
- mit stufenlos verstellbarem Brausehalter NY.BRH 91,
- Aufnahmekonus passend für Handbrausen unterschiedlicher Fabrikate, mit seitlichem Vielzweckhaken,
- mit Rosetten Ø 70 mm zur verdeckten Verschraubung,
- Rosettenunterlage aus Nylon zur schonenden Wandauflage,
- max. zul. Belastung: 175 kg,
- Lieferung mit Edelstahl Torx-Schrauben Ø 6 x 70 mm und Dübeln für Vollbaustoffe und Wände mit Hinterfüterung aus Holz,
- geeignet für NORMBAU Einhängesitze.

Shower handrail with shower head rail

- 500 x 1200mm, 32mm dia.,
- made of stainless steel with powder coating, colour white (019), with antibacterial protection,
- with shower head holder NY.BRH 91,
- shower head holder suitable for various hand shower heads, with multi-purpose side hook,
- with roses 70mm dia. for concealed screw fixing,
- rose inner made of Nylon in order to protect the wall,
- maximum loading permitted: 175kgs,
- supplied with 6mm dia. x 70mm stainless Torx screws and plugs for solid masonry and walls with backfill made of wood,
- suitable for NORMBAU suspendable shower seats.

ⓘ Für den Einsatz von Dichtronden 2053 601/2053 610 geeignet.

ⓘ For the use of round blanks 2053 601/2053 610.

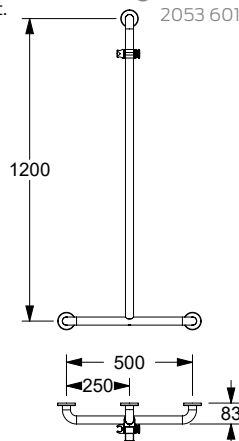

Duschhandlauf mit Brausehalterstange Shower handrail with shower head rail

Code PG 3700

▶ 500 x 1200 mm **1485 350** 171,00 €



Duschhandlauf mit Brausehalterstange

- 750 x 750 x 1200 mm, Ø 32 mm,
- links und rechts einsetzbar,
- weitere Beschreibung wie oben.

Shower handrail with shower head rail

- 750 x 750 x 1200mm, 32mm dia.,
- left and right hand applicable,
- further description see above.

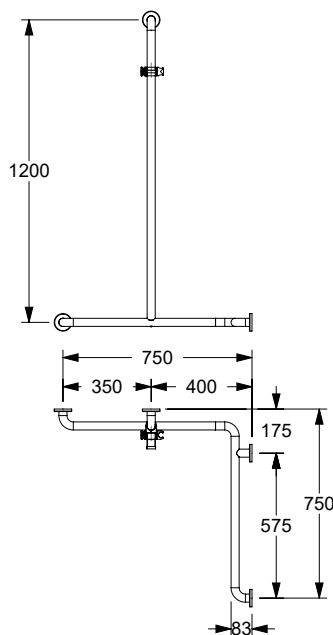

Duschhandlauf mit Brausehalterstange Shower handrail with shower head rail

Code PG 3700

▶ 750 x 750 x 1200 mm **1486 375** 237,00 €



Brausehalterstange

- Achsmaß 1200 mm, Ø 32 mm,
- aus Edelstahl mit Pulverbeschichtung, Farbe weiß (019), mit antibakteriellem Schutz,
- mit stufenlos verstellbarem Brausehalter NY.BRH 91,
- Aufnahmekonus passend für Handbrausen unterschiedlicher Fabrikate, mit seitlichem Vielzweckhaken,
- mit Rosetten Ø 70 mm zur verdeckten Verschraubung,
- Rosettenunterlage aus Nylon zur schonenden Wandaufgabe,
- max. zul. Belastung: 125 kg,
- Lieferung mit Edelstahl Torx-Schrauben Ø 6 x 70 mm und Dübeln für Vollbaustoffe und Wände mit Hinterfüterung aus Holz.

Shower head rail

- axial dimensions 1200mm, 32mm dia.,
- made of stainless steel with powder coating, colour white (019), with antibacterial protection,
- with shower head holder NY.BRH 91,
- shower head holder suitable for various hand shower heads, with multi-purpose side hook,
- with roses 70mm dia. for concealed screw fixing,
- rose inner made of Nylon in order to protect the wall,
- maximum loading permitted: 125kgs,
- supplied with 6mm dia. x 70mm stainless Torx screws and plugs for solid masonry and walls with backfill made of wood.

① Für den Einsatz von Dichtronden 2053 601/2053 610 geeignet.

① For the use of round blanks 2053 601/2053 610.

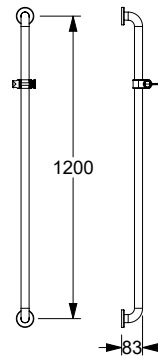

Braushalterstange Shower head rail

Code PG 3700

▶ 1200 mm

1488 320

107,00 €

Klappsitz mit Stützfuß

- 440 x 395 mm,
- Sitzhöhe 460 - 500 mm,
- weiße Sitzfläche und Abdeckung für Montageplatte aus Kunststoff,
- Platz sparend, im hochgeklappten Zustand automatisch arretiert mit einer Ausladung 80 mm,
- max. zul. Belastung 170 kg,
- verdeckte Verschraubung,
- Lieferung mit Schrauben Ø 6 x 60 mm und Dübeln für Vollbaustoffe.

Lift-up shower seat with floor support

- 440 x 395mm
- seating height 460 - 500mm,
- white seat and cover for mounting plate made of plastic,
- space required in vertical position 80mm from wall, automatic built-in stop in lift-up position,
- maximum loading permitted: 170kgs,
- concealed screw fixing,
- supplied with dia. 6 x 60mm and plugs for solid masonry.



Klappsitz mit Stützfuß

Lift-up shower seat with floor support

▶ 440 x 395 mm

Code PG 3700

1844 440

179,00 €

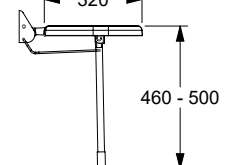
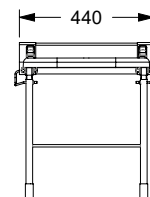
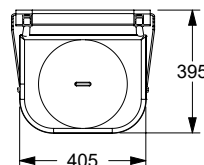



NEW



Duschklapsitz
Lift-up shower seat

Code PG 3800

▶ 412 x 444 mm **3500 010** 279,00 €

Duschklapsitz

- 412 x 444 x 481 (128) mm,
- Wandhalterung aus Edelstahl, kratzfeste Pulverbeschichtung,
- Trägerkonsole aus Aluminium, kratzfeste Pulverbeschichtung,
- Sitzfläche aus thermoplastischem Kunststoff Polypropylen,
- ergonomisch geformte Sitzfläche mit abgerundeten Außenkanten,
- lieferbar in den Nylon-Farben dunkelgrau (018) und weiß (019),
- mit einstellbarer Bremse,
- einfache Montage,
- belastbar bis 150 kg,
- erfüllt die Anforderungen nach DIN 18040 und ÖNORM.

ⓘ Das Montageset 0448 952 ist separat bestellbar.

Lift-up shower seat

- 412 x 444 x 481 (128)mm,
- wall bracket made of stainless steel scratch-resistant powder coating,
- support bracket made of aluminium scratch-resistant powder coating,
- seat made of thermoplastic polypropylene,
- ergonomically visible seat with rounded outer edges,
- available in Nylon colours dark grey (018) and white (019),
- with adjustable brake,
- locked in the upright position,
- easy construction,
- maximum loading permitted: 150kgs,
- meets the requirements of DIN 18040 and ÖNORM.

ⓘ The fixing set 0448 952 has to be ordered separately.

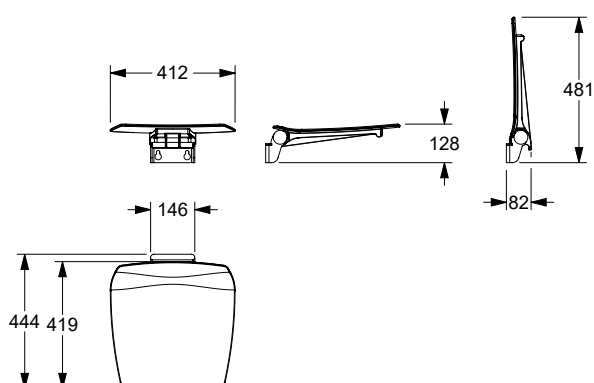

NEW



Duschklapsitz mit Bodenstütze
Lift-up shower seat with floor support

Code PG 3800

▶ 412 x 444 mm **3500 015** 303,00 €

Duschklapsitz mit Bodenstütze

- 412 x 444 x 529 (470-500) mm,
- mit zwangsgeführter Bodenstütze,
- für Sitzhöhe 470-500 mm,
- Wandhalterung aus Edelstahl, kratzfeste Pulverbeschichtung,
- Trägerkonsole aus Aluminium, kratzfeste Pulverbeschichtung,
- Bodenstütze aus Aluminium, kratzfeste Pulverbeschichtung,
- Sitzfläche aus thermoplastischem Kunststoff Polypropylen,
- ergonomisch geformte Sitzfläche mit abgerundeten Außenkanten,
- lieferbar in den Nylon-Farben dunkelgrau (018) und weiß (019),
- mit einstellbarer Bremse,
- einfache Montage,
- belastbar bis 150 kg,
- erfüllt die Anforderungen nach DIN 18040 und ÖNORM.

ⓘ Das Montageset 0448 952 ist separat bestellbar.

Shower seat with floor support

- 412 x 444 x 529 (470-500)mm,
- with positively driven floor support,
- for seat height 470-500mm,
- wall bracket made of stainless steel, scratch-resistant powder coating,
- support bracket made of aluminium, scratch-resistant powder coating,
- aluminum floor support, scratch-resistant,
- seat made of thermoplastic polypropylene,
- ergonomically visible seat with rounded outer edges,
- available in Nylon colours dark grey (018) and white (019),
- with adjustable brake,
- easy construction,
- maximum loading permitted: 150kgs,
- meets the requirements of DIN 18040 and ÖNORM.

ⓘ The fixing set 0448 952 has to be ordered separately.

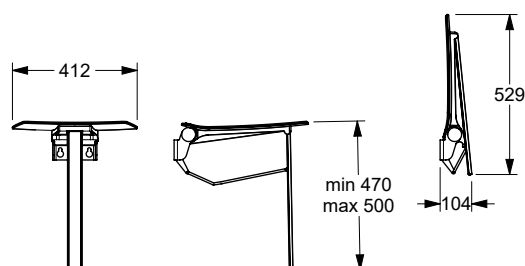

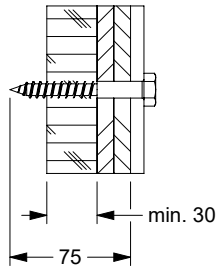

Montageset zur Befestigung an

Vorwandinstallationen mit integrierter Befestigungsplatte aus mehrschichtverleimtem Holz als Hinterfütterung.

Leichtbauwänden aus Gipskarton, Spanplatten, Hartfaserplatten, mit einer Hinterfütterung aus mind. 30 mm dickem mehrschichtverleimtem Holz die an der tragenden Konstruktion ausreichend befestigt sein muss.

Fixing set for fixing

in front of the wall with panels and integrated mounting plate made of hardwood.

lightweight partition walls, made of gypsum, flake board and hardboard back with a multilayer laminated wood back lining measuring at least 30 mm thick, which must be adequately fixed to the supporting structure.

Montageset Fixing set

Code PG 2000

MS 4.8 C 2

Code **0448 952** Price 12,50 €



Montageset MS 4.8 C 2

Für Duschklappsitz und Duschklappsitz mit Bodenstütze.

bestehend aus:

2 Sechskant-Holzschrauben
10 x 80 mm (SW 17) aus
Edelstahl A2-AISI 304.

ⓘ Montagesets für andere Wandbeschaffenheiten auf Anfrage erhältlich.

Fixing set MS 4.8 C 2

For Lift-up shower seat and Shower seat with floor support.

composed of:

2 hexagonal wood screws
10 x 80mm (SW 17) made of stainless
steel A2-AISI 304.

ⓘ Fixing sets for other wall substances are available on request.



Duschvorhangstange mit Vorhangringen und Deckenabhangung

- 800 x 800 mm, 900 x 900 mm, 1000 x 1000 mm und 1200 x 1200 mm, Ø 20 mm,
- mit Deckenabhangung 500 mm, Ø 6 mm,
- aus Aluminium mit Pulverbeschichtung, Farbe weiß (019),
- Deckenabhangung auf Maß kürzbar,
- mit Vorhangringen,
- Lieferung mit Edelstahl Torx-Schrauben Ø 6 x 70 mm und Dübeln für Vollbaustoffe und Wände mit Hinterfütterung aus Holz.

Shower curtain rail with curtain rings and ceiling support

- 800 x 800mm, 900 x 900mm, 1000 x 1000mm, 1200 x 1200mm, 20mm dia.,
- with ceiling support, 500mm, 6mm dia,
- made of aluminium with powder coating, colour white (019),
- ceiling support can be cut to size,
- with curtain rings,
- supplied with 6mm dia. x 70mm stainless Torx screws and plugs for solid masonry and walls with backfill made of wood.

Duschvorhangstange Shower curtain rail

Code PG 3700

▶ a = 800 mm **1381 080** 170,00 €
mit 16 Vorhangringen / with 16 curtain rings

▶ a = 900 mm **1381 090** 175,00 €
mit 17 Vorhangringen / with 17 curtain rings

▶ a = 1000 mm **1381 100** 180,00 €
mit 17 Vorhangringen / with 17 curtain rings

▶ a = 1200 mm **1381 120** 185,00 €
mit 21 Vorhangringen / with 21 curtain rings

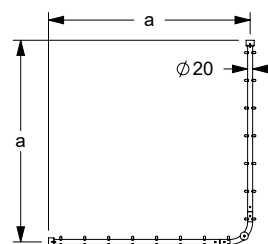
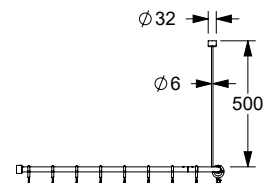



Farbe/colour 019

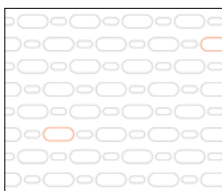

Farbe/colour 051

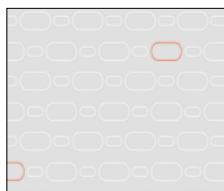

Farbe/colour 052



Farbe/colour 054

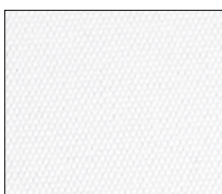

Farbe/colour 059

Duschvorhang

- Höhe 2000 mm, Breite ... mm,
- für Duschvorhangstange NY.DU-VST 1381...
- **aus 100% Polyester, dauerhaft antibakteriell, fungizid, lieferbar in:**
 - **Farbe 019:** weiß mit Struktur,
 - **Farbe 051:** weiß mit ovalem Dekor,
 - **Farbe 052:** grau mit ovalem Dekor,
 - **Farbe 054:** weiß mit Diagonalstreifen.
- **Ausführung Duschvorhang schwer entflammbar,**
 - **Farbe 059: weiß aus Trevira CS,**
 - fungizid,
 - Baustoffklasse B1, DIN 4102, schwer entflammbar,
- bis 40°C waschbar, geeignet zur Desinfektion bis 60°C,
- schnelltrocknend, wasserabweisend,
- mit vernickelten Messing-Ösen für Vorhangringe,
- mit umlaufendem Saum und eingearbeitetem beschichtetem Bleiband,
- weitere Maße auf Anfrage.

❶ Muster der Stoffdekore halten wir bereit, bitte anfordern.

Shower curtain

- height 2000mm, width ... mm,
- for shower curtain rail NY.DU-VST 1381...
- **made of 100% polyester, long-lasting antibacterial, fungicidal, available in:**
 - **colour 019:** white with structure,
 - **colour 051:** white with oval pattern,
 - **colour 052:** grey with oval pattern,
 - **colour 054:** white with diagonal stripes.
- **Shower curtain type flame retardant**
 - **colour 059 white, material Trevira CS,**
 - fungicidal,
 - building material category B1, DIN 4102, flame retardant,
- till 40°C washable, suitable for disinfection, up to 60°C,
- quick drying and water repellent,
- with nickel-plated brass eyelets for curtain rings,
- hemmed and with a sewn in coated lead band,
- further dimensions on request.

❶ We stock samples, please contact us to request them.

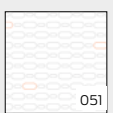
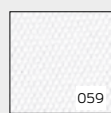
Duschvorhangstange Shower curtain rail a/a ₁	Ösen- anzahl Eyelets	Bezeichnung Product description	Bestell-Nr. Product code PG 1900	 019	 051	 052	 054	 059
800 mm	15	2100 x 2000 mm	0787 340 ...	124,00 €	145,00 €		297,00 €	297,00 €
900 mm	16	2400 x 2000 mm	0787 350 ...	127,00 €	151,00 €		331,00 €	331,00 €
1000 mm	16	2400 x 2000 mm	0787 350 ...	127,00 €	151,00 €		331,00 €	331,00 €
1200 mm	20	3000 x 2000 mm	0787 370 ...	142,00 €	170,00 €		405,00 €	405,00 €



Accessoires | Accessories

Nylon Care



Bereich WC
Toilet area

26 - 29



Bereich Dusche
Shower area

30



Bereich Waschbecken
Wash basin area

31 - 47

Farbkarte Accessoires
Colour Chart accessories

48



Hygienebeutelspender

- 136 x 91 x 27 mm,
- aus Edelstahl Werkstoff Nr. 1.4301 (A2-AISI 304),
- kratzfeste Pulverbeschichtung mit antibakteriellem Schutz,
- lieferbar in Farbe weiß (092),
- zur Aufnahme und Entnahme von handelsüblichen Hygienebeuteln,
- zur Wandmontage,
- Lieferung mit Schrauben und Dübeln.

Hygiene bag dispenser

- 136 x 91 x 27mm,
- made of stainless steel, material No. 1.4301 (A2-AISI 304),
- scratch-resistant powder coating with antibacterial protection, see register information,
- available in colour white (092),
- to take and remove commercially available sanitary bags,
- for wall mounting,
- supplied with plugs and screws.

Hygienebeutelspender Hygiene bag dispenser	Code	PG 7010
▶ 136 x 91 x 27 mm	7520 180	55,50 €

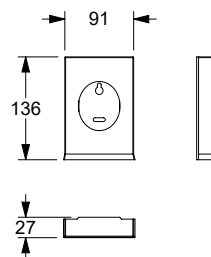

WC-Bürstengarnitur

- Gesamthöhe 380 mm,
- aus Nylon, Konsole aus PMMA,
- erhältlich in den Nylon-Farben (ausgenommen 028 Verkehrsgrau),
- mit austauschbarem schwarzem Bürstenkopf,
- Lieferung mit Schrauben und Dübeln,
- Ersatzbürstenkopf, Farbe schwarz.

Toilet brush

- set, total height 380mm,
- made of Nylon, holder made of PMMA,
- available in Nylon colours (except 028 traffic grey),
- with removable black brush head,
- supplied with plugs and screws,
- toilet brush head, colour black.

WC-Bürstengarnitur Toilet brush	Code	PG 1500
▶ 380 x 120 x 126 mm WC-Bürstengarnitur/toilet brush set	0824 050	59,00 €
▶ 365 x Ø 86 mm WC-Ersatzbürste/spare toilet brush	0824 060	16,25 €
▶ 82 x Ø 86 mm WC-Ersatzbürstenkopf/ spare toilet brush head	0925 460	10,00 €

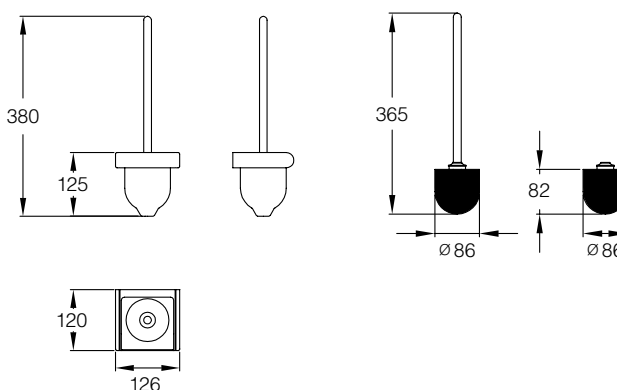



WC-Bürstengarnitur

- Gesamthöhe 512 mm,
- aus Nylon, optional mit antibakteriellem Schutz,
- erhältlich in den Nylon-Farben,
- Bürstentopf drehbar und zur Reinigung abnehmbar,
- mit zusätzlicher Einsenkung zur Aufnahme von Desinfektionsmitteln,
- trichterförmiger Bürstentopf zum einfachen Einstecken der Bürste,
- langer Bürstenstiel mit ergonomisch geformtem Griffende,
- mit austauschbarem schwarzem Bürstenkopf,
- Lieferung mit Schrauben $\varnothing 5 \times 80$ mm und Universal-Dübeln,
- Ersatzbürstenkopf, Farbe schwarz.

Toilet brush

- total height 512mm,
- made of Nylon, on request with antibacterial protection,
- available in Nylon colours,
- rotating upper holder and removable for cleaning,
- with additional recess for disinfectant,
- conical inner receptacle and brush head for easy insertion,
- long brush handle with ergonomic grip,
- with removable black brush head,
- supplied with 5mm dia. x 80mm screws and plugs,
- toilet brush head, colour black.

WC-Bürstengarnitur Toilet brush	Code	PG 0700
▶ 512 x 148 x 135 mm	0300 444	82,50 €
▶ 512 x 148 x 135 mm, Antibac	4300 444	91,00 €
Bürstengarnitur/Toilet brush set		
▶ 486 x $\varnothing 86$ mm	0300 445	22,25 €
▶ 486 x $\varnothing 86$ mm, Antibac	4300 445	25,25 €
Ersatzbürste/Spare toilet brush		
▶ 82 x $\varnothing 86$ mm	0300 446	10,50 €
Ersatzbürstenkopf/Spare toilet brush head		
▶ 211 x $\varnothing 123$ mm	0300 449	23,00 €
Ersatzbürstentopf Toilet brush pot		

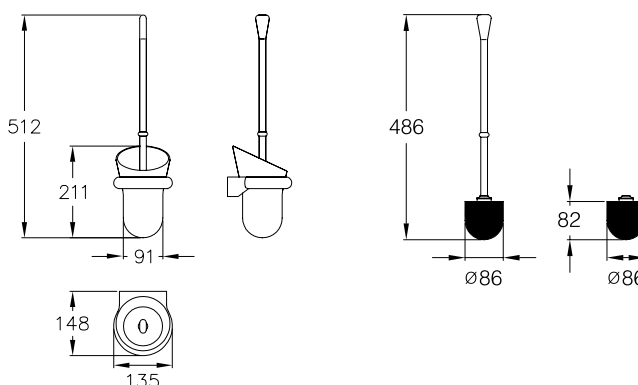

WC-Bürstengarnitur

- Gesamthöhe 520 mm,
- aus Nylon, optional mit antibakteriellem Schutz,
- erhältlich in den Nylon-Farben,
- einstellbarer Diebstahlschutz,
- Bürstentopfoberteil drehbar,
- zur Reinigung abnehmbar,
- langer Bürstenstiel mit ergonomisch geformtem Griffende,
- mit austauschbarem schwarzem Bürstenkopf,
- Lieferung mit Schrauben $\varnothing 5 \times 80$ mm und Universal-Dübeln,
- Ersatzbürstenkopf, Farbe schwarz.

Toilet brush

- total height 520mm,
- made of Nylon, on request with antibacterial protection,
- available in Nylon colours,
- with anti-theft device,
- rotating upper brush head,
- removable for cleaning,
- long brush handle with ergonomic grip,
- with removable black brush head,
- supplied with 5mm dia. x 80mm screws and plugs,
- toilet brush head, colour black.

WC-Bürstengarnitur Toilet brush	Code	PG 0200
▶ 520 x 148 x 135 mm	0925 400	100,00 €
▶ 520 x 148 x 135 mm, Antibac	4925 400	116,00 €
WC-Bürstengarnitur/Toilet brush set		
▶ 486 x $\varnothing 86$ mm	0925 450	22,25 €
▶ 486 x $\varnothing 86$ mm, Antibac	4925 450	25,25 €
WC-Ersatzbürste/Spare toilet brush		
▶ 82 x $\varnothing 86$ mm	0925 460	10,00 €
WC-Ersatzbürstenkopf/Spare toilet brush head		
▶ 260 x $\varnothing 107$ mm	0925 490	15,25 €
Ersatzbürstentopf Toilet brush pot		

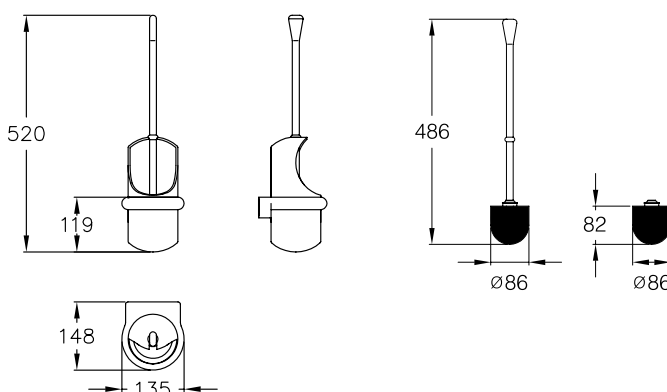



Papierrollenhalter

- 135 x 155 mm, oval 11 x 18 mm,
- aus Nylon,
- erhältlich in den Nylon-Farben,
- Lieferung mit Schrauben und Dübeln.

Toilet roll holder

- 135 x 155mm, oval 11 x 18mm,
- made of Nylon,
- available in Nylon colours,
- supplied with plugs and screws.

Papierrollenhalter Toilet roll holder

Code PG 1500

- ▶ NY.PRH 74
135 x 155 mm

0149 010 20,25 €

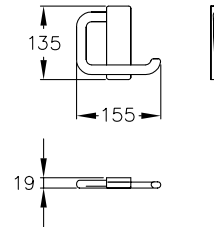

Papierrollenhalter

- 125 x 160 mm,
- aus Nylon, optional mit antibakteriellem Schutz,
- erhältlich in den Nylon-Farben,
- verdeckte Verschraubung,
- alternativ mit Dornschlüssel,
- Lieferung mit Schrauben Ø 4 x 40 mm und Dübeln.

Toilet roll holder

- 125 x 160mm,
- made of Nylon, on request with antibacterial protection,
- available in Nylon colours,
- concealed screw fixing,
- alternatively supplied with anti-theft key,
- supplied with 4mm dia. x 40mm screws and plugs.

Papierrollenhalter Toilet roll holder

Code PG 1500

- ▶ NY.PRH 80
125 x 160 mm
- 125 x 160 mm, Antibac

0399 010 24,75 €
4399 010 27,50 €

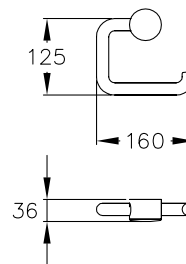

- ▶ NY.PRH 80 S
125 x 160 mm
- 125 x 160 mm, Antibac
inkl. Dornschlüssel/incl. anti-theft key

0399 020 27,75 €
4399 020 32,75 €

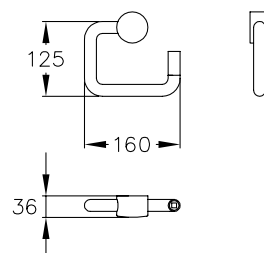



Ersatzrollenhalter

- Länge 126 mm, Ø 34 mm,
- aus Nylon, optional mit antibakteriellem Schutz,
- erhältlich in den Nylon-Farben,
- verdeckte Verschraubung,
- Lieferung mit Schrauben Ø 4 x 40 mm und Dübeln.

Spare toilet roll holder

- length 126mm, 34mm dia.,
- made of Nylon, on request with antibacterial protection,
- available in Nylon colours,
- concealed screw fixing,
- supplied with 4mm dia. x 40mm screws and plugs.

Ersatzrollenhalter Spare toilet roll holder	Code	PG 1500
▶ NY.ERH 81 L= 126 mm	0518 010	32,25 €
L= 126 mm, Antibac	4518 010	36,25 €

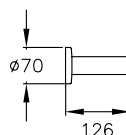

Ersatzrollenhalter

- 190 x 107 mm, 290 x 107 mm, Ø 34 mm,
- aus Nylon, optional mit antibakteriellem Schutz,
- erhältlich in den Nylon-Farben,
- verdeckte Verschraubung,
- Lieferung mit Schrauben Ø 6 x 70 mm und Dübeln.

Spare toilet roll holder

- 190 x 107mm, 290 x 107mm, 34mm dia.,
- made of Nylon, on request with antibacterial protection,
- available in Nylon colours,
- concealed screw fixing,
- supplied with 6mm dia. x 70mm screws and plugs.

Ersatzrollenhalter Spare toilet roll holder	Code	PG 1500
▶ NY.ERH 82.1 190 x 107 mm	0518 110	84,50 €
190 x 107 mm, Antibac	4518 110	94,00 €
▶ NY.ERH 82.2 290 x 107 mm	0518 120	88,00 €
290 x 107 mm, Antibac 2-fach / for two rolls	4518 120	97,50 €

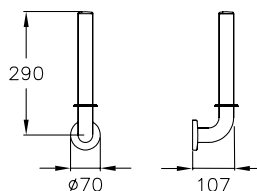
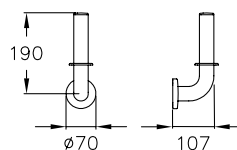



Eckablage

- 170 x 170 x 63 mm,
- aus Nylon, optional mit antibakteriellem Schutz,
- erhältlich in den Nylon-Farben,
- Ablagefläche 200 cm² groß,
- Ablageschale zur Reinigung ohne Werkzeug abnehmbar,
- mit rückseitigem Wasserablauf und zusätzlichem Ablaufloch,
- zur Montage sind nur zwei Befestigungsbohrungen erforderlich,
- Lieferung mit Schrauben und Dübeln.

Bathroom corner shelf

- 170 x 170 x 63mm,
- made of Nylon, on request with antibacterial protection,
- available in Nylon colours,
- storage space 200cm²,
- insert removable without the need of tools for cleaning purpose,
- with waterdrain at the rear and additional drain hole,
- only two drilling holes required for fixing,
- supplied with plugs and screws.

Eckablage

Bathroom corner shelf

Code PG 0200

▶ 170 x 170 x 63 mm	0925 330	117,00 €
170 x 170 x 63 mm, Antibac	4925 330	129,00 €

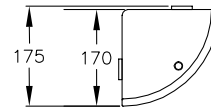
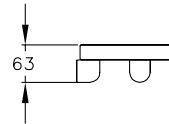

Duschablage mit Klemmhalterung

- 210 x 110 x 75 mm,
- aus Nylon, optional mit antibakteriellem Schutz,
- erhältlich in den Nylon-Farben,
- Ablagefläche 200 cm² groß,
- zum Aufklipsen auf NORMBAU Nylon- und Edelstahl Duschhandläufe oder für Wandmontage mit Kleberonden,
- Ablagefläche mit rutschhemmender Noppenstruktur und Ablaufloch,
- Lieferung mit Klemmhalterung für Rohrmontage.

Shower box with clamping device

- 210 x 110 x 75mm,
- made of Nylon, on request with antibacterial protection,
- available in Nylon colours,
- storage space 200cm²,
- for clamping to NORMBAU Nylon- and Stainless shower handrails or for fixing to wall with self-adhesive stickers,
- the shower box bottom has a structured non-slip surface as well as a drain hole,
- supplied with clamping device for mounting on Nylon tube.

Duschablage

Shower box

Code PG 0200

▶ 210 x 110 x 75 mm	0925 350	45,25 €
210 x 110 x 75 mm, Antibac	4925 350	50,50 €

... für Wandmontage
... for wall fixing

▶ 210 x 110 x 75 mm	0925 360	45,25 €
210 x 110 x 75 mm, Antibac	4925 360	50,50 €

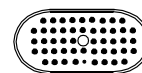
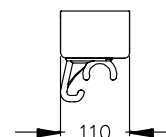
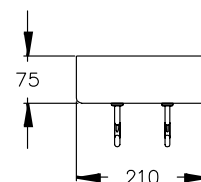



Duschablage, nachrüstbar

- 160 x 80 x 50 mm,
- für Nylon Brausestangen, Ø 34 mm,
- Ablagefläche 100 cm²,
- aus Nylon, optional mit antibakteriellem Schutz,
- erhältlich in den NORMBAU Farben,
- Ablagefläche mit Ablaufloch.

Shower box, may be added at a later stage

- 160 x 80 x 50mm,
- for Nylon shower head rail 34mm dia.,
- storage space 100cm²,
- made of Nylon, on request with antibacterial protection,
- available in Nylon colours,
- the shower box bottom has a drain hole.

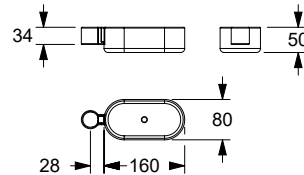

Duschablage Shower box

Code PG 0200

▶ 160 x 80 x 50 mm	0925 380	45,25 €
▶ 160 x 80 x 50 mm Antibac	4925 380	50,50 €



Ablage

- Länge 210 mm,
- aus Nylon, optional mit antibakteriellem Schutz,
- erhältlich in den Nylon-Farben,
- Oberteil zur Reinigung abnehmbar,
- mit oder ohne Ablaufloch,
- mit einstellbarem Diebstahlschutz,
- Lieferung mit Schrauben und Dübeln.

Bathroom shelf

- length 210mm,
- made of Nylon, on request with antibacterial protection,
- available in Nylon colours,
- top removable for cleaning,
- with or without drain hole,
- with anti-theft device,
- supplied with plugs and screws.

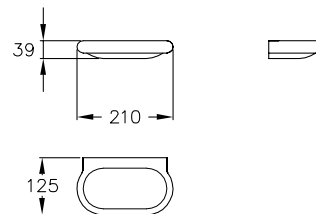

Ablage

Bathroom shelf

Code PG 0200

▶ L= 210 mm	0925 220	84,50 €
▶ L= 210 mm, Antibac ohne Ablaufloch, without drain hole	4925 220	94,00 €
▶ L= 210 mm	0925 210	91,50 €
▶ L= 210 mm, Antibac mit Ablaufloch, with drain hole	4925 210	102,00 €



Ablage

- Länge 600 mm
- aus Nylon, optional mit antibakteriellem Schutz,
- erhältlich in den Nylon-Farben,
- Oberteil zur Reinigung abnehmbar,
- mit einstellbarem Diebstahlschutz,
- Lieferung mit Schrauben und Dübeln.

Bathroom shelf

- length 600mm,
- made of Nylon, on request with antibacterial protection,
- available in Nylon colours,
- top removable for cleaning,
- with anti-theft device,
- supplied with plugs and screws.

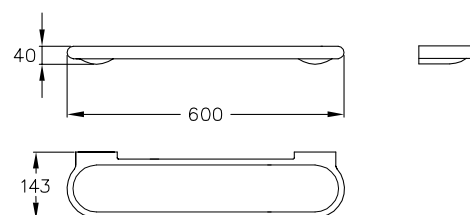

Ablage

Bathroom shelf

Code PG 0200

▶ L= 600 mm	0925 260	192,00 €
▶ L= 600 mm, Antibac	4925 260	222,00 €



Ablagekonsole

- Länge 676 mm,
- aus PMMA,
- erhältlich in den Nylon-Farben (ausgenommen 028 Verkehrsgrau),
- verdeckte Verschraubung,
- Lieferung mit Schrauben und Dübeln.

Bathroom shelf

- length 676mm,
- made of PMMA,
- available in Nylon colours (except 028 traffic grey),
- concealed screw fixing,
- supplied with plugs and screws.

Ablagekonsole Bathroom shelf

Code PG 1500

▶ L = 676 mm

0826 010

93,00 €

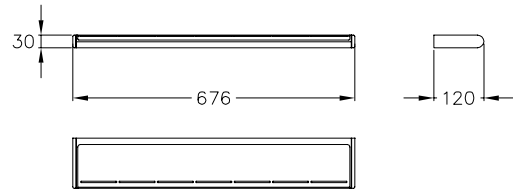

Ablagekonsole

- Länge 300 mm,
- aus Nylon,
- erhältlich in den Nylon-Farben,
- verdeckte Verschraubung,
- Lieferung ohne Schrauben Ø 4 mm und Dübel.

Bathroom shelf

- length 300mm,
- made of Nylon,
- available in Nylon colours,
- concealed screw fixing,
- supplied without plugs and screws 4mm dia.



Ablagekonsole Bathroom shelf

Code PG 1500

▶ NY.AKO 76
L = 300 mm

0146 010

35,75 €

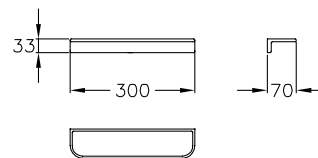

Seifenschale

- 120 x 126 mm,
- aus PMMA,
- erhältlich in den Nylon-Farben (ausgenommen 028 Verkehrsgrau),
- mit oder ohne Ablaufloch,
- verdeckte Verschraubung,
- Lieferung mit Schrauben und Dübeln.

Soap dish

- 120 x 126mm,
- made of PMMA,
- available in Nylon colours (except 028 traffic grey),
- with or without drain hole,
- concealed screw fixing,
- supplied with plugs and screws.



Seifenschale Soap dish

Code PG 1500

▶ 120 x 126 mm
ohne Ablaufloch
without drain hole

0824 020

25,50 €

▶ 120 x 126 mm
mit Ablaufloch
with drain hole

0824 010

25,50 €

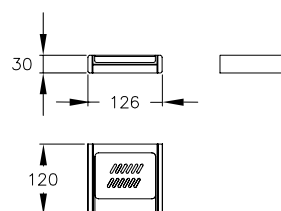

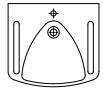

Seifenablage

- 125 x 116 mm,
- aus Nylon, optional mit antibakteriellem Schutz,
- erhältlich in den Nylon-Farben,
- Oberteil zur Reinigung abnehmbar,
- ohne Ablaufloch,
- mit einstellbarem Diebstahlschutz,
- Lieferung mit Schrauben und Dübeln.

Soap dish

- 125 x 116mm,
- made of Nylon, on request with antibacterial protection,
- available in Nylon colours,
- top removable for cleaning,
- without drain hole,
- with anti-theft device,
- supplied with plugs and screws.

Seifenablage Soap dish

Code PG 0200

- | | | |
|-------------------------|-----------------|---------|
| ▶ 125 x 116 mm | 0925 020 | 42,00 € |
| ▶ 125 x 116 mm, Antibac | 4925 020 | 46,75 € |

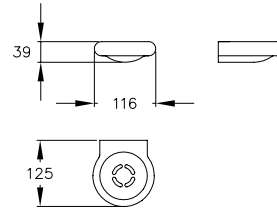

Becherhalter mit Becher

- 125 x 116 mm,
- aus Nylon, optional mit antibakteriellem Schutz,
- erhältlich in den Nylon-Farben,
- Oberteil zur Reinigung abnehmbar,
- mit einstellbarem Diebstahlschutz,
- verdeckte Verschraubung,
- Lieferung mit Schrauben und Dübeln.

Tumbler holder with tumbler

- 125 x 116mm,
- made of Nylon, on request with antibacterial protection,
- available in Nylon colours,
- top removable for cleaning,
- with anti-theft device,
- concealed screw fixing,
- supplied with plugs and screws.

- Becher, Ø 72 mm, Höhe 88 mm,
- aus Nylon, optional mit antibakteriellem Schutz,
 - erhältlich in den Nylon-Farben.

- Tumbler, 72mm dia., height 88mm,
- made of Nylon, optional with antibacterial protection,
 - available in Nylon colours.

Becherhalter mit Becher Tumbler holder with tumbler

Code PG 0200

- | | | |
|-------------------------|-----------------|---------|
| ▶ 125 x 116 mm | 0925 110 | 53,00 € |
| ▶ 125 x 116 mm, Antibac | 4925 110 | 59,00 € |
- Becherhalter mit Becher
Tumbler holder with tumbler

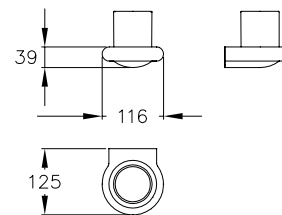

- | | | |
|-------------------------|-----------------|---------|
| ▶ 125 x 116 mm | 0925 100 | 38,00 € |
| ▶ 125 x 116 mm, Antibac | 4925 100 | 42,25 € |
- Becherhalter/Tumbler holder

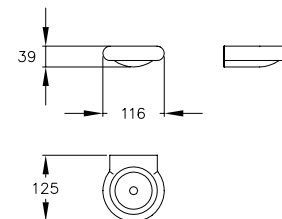

- | | | |
|--------------------|-----------------|---------|
| ▶ Ø 72 mm | 0925 160 | 15,25 € |
| ▶ Ø 72 mm, Antibac | 4925 160 | 17,00 € |
- Becher, Höhe 88 mm
Tumbler, height 88mm



Handtuchhalter

- 220 x 150 mm, Ø 20 mm,
- aus Nylon, optional mit antibakteriellem Schutz,
- erhältlich in den Nylon-Farben,
- verdeckte Verschraubung,
- Lieferung mit Schrauben und Dübeln.

Towel holder

- 220 x 150mm, 20mm dia.,
- made of Nylon, on request with antibacterial protection,
- available in Nylon colours,
- concealed screw fixing,
- supplied with plugs and screws.

Handtuchhalter Towel holder

Code PG1500

▶ NY.HHA 80	0506 010	64,00 €
220 x 150 mm		
220 x 150 mm, Antibac	4506 010	71,50 €

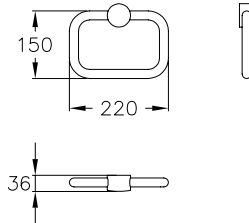

Handtuch-/Rollenhalter

- 340 x 125 mm, Ø 20 mm,
- aus Nylon, optional mit antibakteriellem Schutz,
- erhältlich in den Nylon-Farben,
- verdeckte Verschraubung,
- Lieferung mit Schrauben und Dübeln.

Towel or tissue roll holder

- 340 x 125mm, 20mm dia.,
- made of Nylon, on request with antibacterial protection,
- available in Nylon colours,
- concealed screw fixing,
- supplied with plugs and screws.

Handtuchhalter Towel holder

Code PG1500

▶ 340 x 125 mm	0583 020	35,00 €
340 x 125 mm, Antibac	4583 020	38,00 €

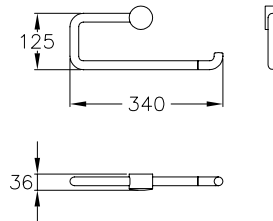

Handtuchhalter, schwenkbar

- Länge 450 mm, Ø 20 mm,
- aus Nylon, optional mit antibakteriellem Schutz,
- erhältlich in den Nylon-Farben,
- beide Stangen schwenkbar,
- verdeckte Verschraubung,
- Lieferung mit Schrauben und Dübeln.

Swivel towel holder

- length 450mm, 20mm dia.,
- made of Nylon, on request with antibacterial protection,
- available in Nylon colours,
- both bars are swivel-mounted,
- concealed screw fixing,
- supplied with plugs and screws.

Handtuchhalter schwenkbar Swivel towel holder

Code PG1500

▶ L= 450 mm	0582 010	117,00 €
L= 450 mm, Antibac	4582 010	129,00 €

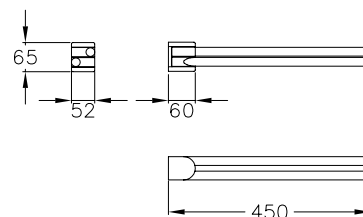



Handtuchstange

- Achsmaß 450, 600, Ø 26 mm,
- aus Nylon, optional mit antibakteriellem Schutz,
- erhältlich in den Nylon-Farben,
- ohne Rosetten,
- verdeckte Verschraubung,
- Lieferung mit Schrauben und Dübeln.

Towel rail

- axial dimension 450, 600, 26mm dia.,
- made of Nylon, on request with antibacterial protection,
- available in Nylon colours,
- without roses,
- concealed screw fixing,
- supplied with plugs and screws.

Handtuchstange Code PG 1500
Towel rail

ohne Rosetten, zur Befestigung an Mauerwerk
without roses, for fixing onto brickworks

▶ NY.HST 450	0528 010	71,50 €
NY.HST 450, Antibac a= 450 mm	4528 010	82,00 €
▶ NY.HST 600	0528 020	87,50 €
NY.HST 600 Antibac a= 600 mm	4528 020	96,50 €

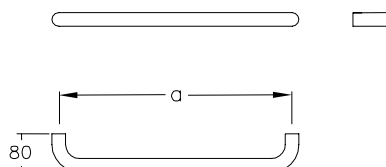

Handtuchstange

- Achsmaß 450, 600, Ø 26 mm,
- aus Nylon, optional mit antibakteriellem Schutz,
- erhältlich in den Nylon-Farben,
- mit Rosetten Ø 60 mm,
- verdeckte Verschraubung,
- Lieferung mit Schrauben und Dübeln.

Towel rail

- axial dimension 450, 600mm, 26mm dia.,
- made of Nylon, on request with antibacterial protection,
- available in Nylon colours,
- with roses 60mm dia.,
- concealed screw fixing,
- supplied with plugs and screws.

mit Rosetten, zur Befestigung an Mauerwerk
with roses, for fixing onto brickworks

▶ NY.HST 450	0528 110	70,50 €
NY.HST 450, Antibac a= 450 mm	4528 110	82,00 €
▶ NY.HST 600	0528 120	84,50 €
NY.HST 600, Antibac a= 600 mm	4528 120	96,50 €

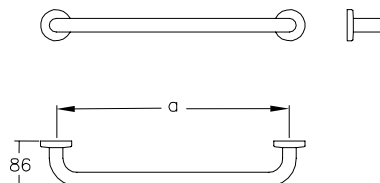



Handtuchstange

- Achsmaß 400, 600, 800, 1000, 1100 mm, Ø 34 mm,
- aus Nylon,
- mit rutschsicherer Griffzone durch strukturiertes Rohr oder mit glattem Rohr,
- erhältlich in den Nylon-Farben,
- ausgesteift mit korrosionsgeschütztem Stahlkern,
- mit Rosetten Ø 70 mm,
- verdeckte Verschraubung,
- Lieferung mit Schrauben und Dübeln.

Towel rail

- axial dimension 400, 600, 800, 1000, 1100mm, 34mm dia.,
- made of Nylon,
- with non-slip textured surface or with smooth surface,
- available in Nylon colours,
- reinforced with non-corrosive steel core,
- with roses 70mm dia.,
- concealed screw fixing,
- supplied with plugs and screws.

Handtuchstange Towel rail

Code PG 1500

... strukturiertes Rohr, mit Rosetten ... textured surface, with roses

▶ NY.444.410 MS 1.9B, a = 400 mm	0444 410	105,00 €
▶ NY.444.420 MS 1.9B, a = 600 mm	0444 420	113,00 €
▶ NY.444.430 MS 1.9B, a = 800 mm	0444 430	139,00 €
▶ NY.444.440 MS 1.9B, a = 1000 mm	0444 440	169,00 €
▶ NY.444.450 MS 1.9B, a = 1100 mm	0444 450	176,00 €

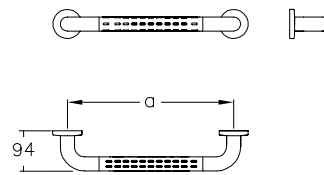

... glattes Rohr, mit Rosetten ... smooth surface, with roses

▶ NY.444.220 MS 1.9B, a = 600 mm	0444 220	107,00 €
▶ NY.444.230 MS 1.9B, a = 800 mm	0444 230	114,00 €

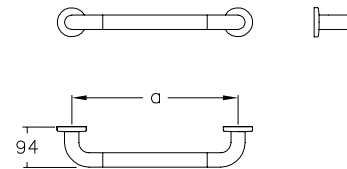



Handtuchstange

- Länge 450 mm, Ø 34 mm,
- aus Nylon,
- mit glatter Oberfläche,
- erhältlich in den Nylon-Farben,
- ausgesteift mit korrosionsgeschütztem Stahlkern,
- glattes Rohr mit Rosetten Ø 70 mm,
- verdeckte Verschraubung,
- Lieferung mit Schrauben und Dübeln für Vollbaustoffe.

Towel rail

- length 450mm, 34mm dia.,
- made of Nylon,
- with smooth or non-slip textured surface,
- available in Nylon colours,
- reinforced with non-corrosive steel core,
- smooth surface with roses 70mm dia.,
- smooth tube with 70mm dia. roses,
- concealed screw fixing,
- supplied with plugs and screws for solid masonry.

Handtuchstange Towel rail

Code PG 1500

▶ L= 450 mm

0436 010

52,50 €

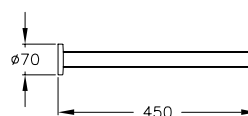

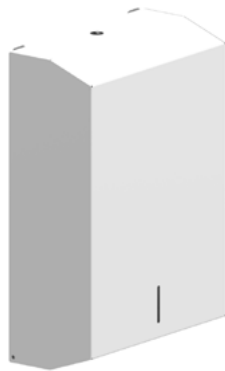

Falthandtuchspender

- 252 x 121 x 371 mm,
- aus Metall, lackiert,
- lieferbar in Farbe weiß (019),
- hygienisch und wirtschaftlich durch Einzeltattentnahme,
- geeignet für Zick-Zack Falz, Lagenfalz und Interfold (ca. 400 – 800 Blatt),
- integrierte Füllstandanzeige,
- reinigungsfreundliche Oberfläche,
- abschließbar,
- Lieferung mit Montageset.

Hand towel dispenser

- 252 x 121 x 371mm,
- made of metal, coated,
- available in colour white (019),
- hygienic and economical due to single sheets removal,
- suitable for ZZ-fold, C-fold and Interfold (ca. 400 – 800 sheets),
- integrated level indicator,
- easy to clean due to smooth surface,
- lockable,
- supplied with fixing set.

Falthandtuchspender Hand towel dispenser

Code PG1500

▶ 252 x 121 x 371 mm **0506 531** 109,00 €

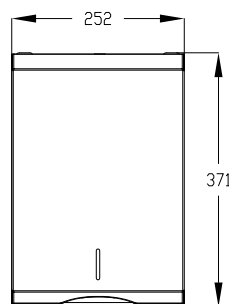

Kosmetiktuchspender

- 286 x 74 x 139 mm,
- aus Edelstahl gebürstet, Werkstoff Nr. 1.4301 (A2-AISI 304),
- Pulverbeschichtung,
- lieferbar in der Farbe weiß (019),
- hygienisch und wirtschaftlich durch Einzeltattentnahme,
- geeignet für alle handelsüblichen Kosmetiktuchboxen (100 und 150 Tücher),
- für Wandmontage,
- Lieferung mit Montageset.

Tissue dispenser

- 286 x 74 x 139mm,
- made of satin stainless steel, material no. 1.4301 (A2-AISI 304),
- powder coating,
- available in colour white (019),
- hygienic and economical due to single sheets removal,
- suitable for all currently available tissue dispenser boxes (100 and 150 tissue),
- for wall mounting,
- supplied with fixing set.



Kosmetiktuchspender Tissue dispenser

Code PG1500

▶ 286 x 74 x 139 mm **0506 533** 95,50 €

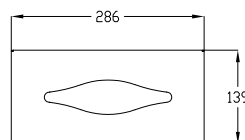



Spiegel

- Breite 600 mm, Länge 600, 1000 mm,
- aus Floatglas 5 mm,
- eckig, polierte Kanten.

① Passend zu Spiegelhalter
0514 010 / 4514 010.

Mirror

- width: 600mm, length: 600, 1000mm,
- made of float glass 5mm,
- angular, polished edges.

① Adaptel to mirror holder
0514 010 / 4514 010.

Spiegel Mirror

	Code	PG1500
▶ 600 x 600 mm	0514 150	113,00 €
▶ 600 x 1000 mm	0514 170	180,00 €

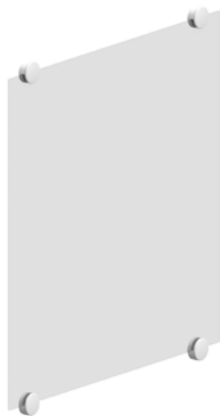
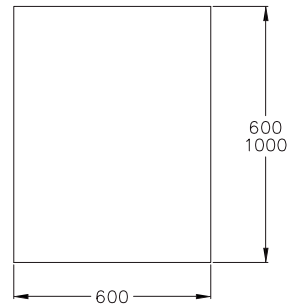

Spiegelhalter

- aus Nylon, optional mit antibakteriellem Schutz,
- erhältlich in den Nylon-Farben,
- für Spiegel bis 6 mm Dicke,
- verdeckte Verschraubung,
- Lieferung mit Schrauben und Dübeln.

Mirror holder

- made of Nylon, on request with antibacterial protection,
- available in Nylon colours,
- for mirrors up to 6mm thickness,
- concealed screw fixing,
- supplied with plugs and screws.

Spiegelhalter Mirror holder

	Code	PG1500
▶ NY.SPH 82.1 Ø 40 mm	0514 010	6,00 €
▶ Ø 40 mm, Antibac	4514 010	7,00 €
pro Stück / per piece		

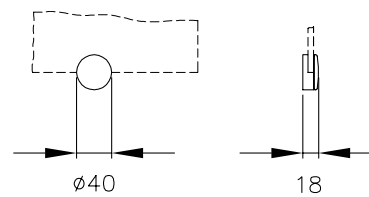



Abfallkorb

- 320 x 250 x 380 mm, 30 l,
- 320 x 255 x 635 mm, 54 l,
- aus Metall, lackiert,
- lieferbar in der Farbe weiß (019),
- Drahtgittergeflecht,
- mit Gummifüßen, besonders rutschfest und kippicher,
- einfache Montage (freistehend oder Wandbefestigung),
- Lieferung mit Montageset.

Waste bin

- 320 x 250 x 380mm, 30 l,
- 320 x 255 x 635mm, 54 l,
- made of metal, coated,
- available in colour white (019),
- wire netting mesh,
- anti-slip function due to rubberized feet,
- easy installation (free standing or wall mounting),
- supplied with fixing set.

Abfallkorb Waste bin

Code PG1500

▶ 320 x 250 x 380 mm **0506 537** 65,50 €

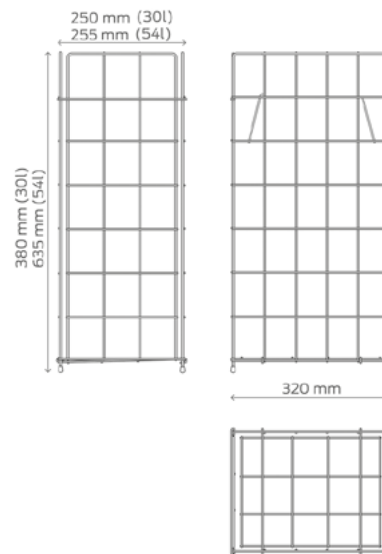
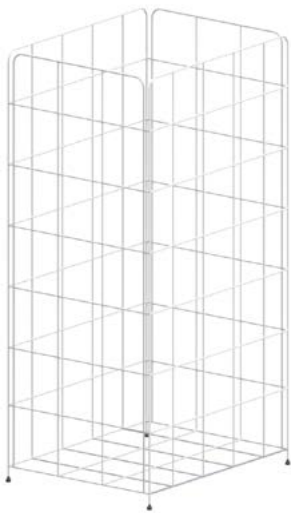

▶ 320 x 255 x 635 mm **0506 538** 78,00 €



Abfallbehälter

- 225 x 250 mm, Ø 170 mm,
- Abfallbehälter aus Stahlblech mit Pulverbeschichtung, Farbe weiß (019),
- mit herausnehmbarem Kunststoffeimer,
- Volumen 3 Liter,
- für Wandbefestigung,
- Deckel ist von Hand zu öffnen,
- Lieferung mit Schrauben und Dübeln.

Waste bin

- 225 x 250mm, 170mm dia.,
- waste bin made of steel plate,
- colour white (019), powder coating,
- inner waste bin can be removed to be emptied or cleaned,
- 3 litre capacity,
- for wall mounting,
- waste bin lid to be opened by hand,
- supplied with screws and plugs.

① Empfohlene Montagehöhe von Boden bis Unterkante Abfallbehälter: 500 mm.

① The recommended fixing height from the floor to the lower edge of the waste bin is 500mm.

Abfallbehälter Waste bin

Code PG 0700

▶ 225 x 250 mm **0300 480** 70,00 €

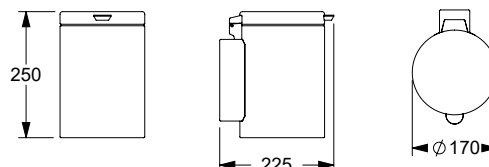



Abfallbehälter

- 170 x 185 x 280 mm, Ø 182 mm,
- Abfallbehälter und Wandhalterung aus Edelstahl,
- Farbe weiß (019), pulverbeschichtet,
- mit herausnehmbarem Kunststoffeimer,
- Volumen 3 Liter,
- mit Touch Öffnungssystem,
- zur Wandmontage oder frei auf dem Boden stehend,
- zur Reinigung aus der Wandhalterung aushängbar,
- Lieferung mit Schrauben und Dübel.

Waste bin

- 170 x 185 x 280mm, 182mm dia.,
- waste bin and wall mounting made of stainless steel,
- colour white (019), powder coating,
- with removable plastic bin,
- 3 litre capacity,
- smooth opening with touch opening system,
- for wall mounting or freestanding on the floor,
- can be removed from wall for cleaning,
- supplied with plugs and screws.

① Empfohlene Montagehöhe von Boden bis Unterkante Abfallbehälter: 470 mm.

① The recommended fixing height from the floor to the lower edge of the waste bin is 470mm.

Abfallbehälter Waste bin

Code PG 1500

▶ 170 x 185 x 280 mm
Ø 182 mm **0300 499** 176,00 €

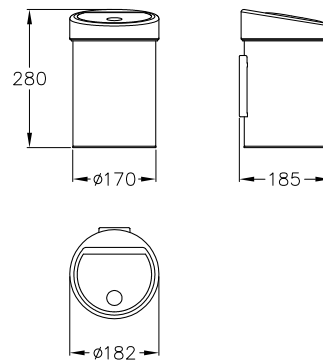

Schwarz



Abfallbehälter

- 226 x 225 x 360 mm,
- Deckel aus Nylon, optional mit antibakteriellem Schutz,
- erhältlich in den Nylon-Farben,
- Behälter Farbe weiß, zur Wandmontage,
- Deckel durch Kniedruck oder von Hand zu öffnen,
- Volumen 8 Liter,
- Behältereinsatz zum Entleeren oder Reinigen herausnehmbar,
- Beutel wird durch Klemmhalterung fixiert,
- Lieferung mit Schrauben und Dübeln.

Waste bin

- 226 x 225 x 360mm,
- top made of Nylon, on request with antibacterial protection,
- available in Nylon colours,
- bin in colour white, for wall mounting,
- waste bin lid can be opened by knee or by hand,
- 8 litre capacity,
- inner waste bin can be removed to be emptied or cleaned,
- with clamp fixing inside for waste bag,
- supplied with plugs and screws.

① Empfohlene Montagehöhe von Boden bis Unterkante Abfallbehälter: 490 mm.

① The recommended fixing height from the floor to the lower edge of the waste bin is 490mm.

Abfallbehälter Waste bin

Code PG 1500

▶ 226 x 225 x 360 mm **0924 480** 240,00 €
226 x 225 x 360 mm **4924 480** 276,00 €
Antibac

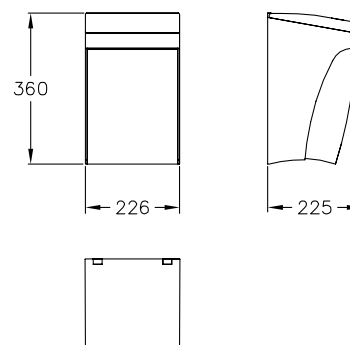



Kleiderbügel

- 436 x 210 mm,
- aus Nylon, optional mit antibakteriellem Schutz,
- erhältlich in den Nylon-Farben,
- für Garderoben bis Ø 38 mm.

Coat hanger

- 436 x 210mm,
- made of Nylon, on request with antibacterial protection,
- available in Nylon colours,
- for wardrobe up to 38mm dia.

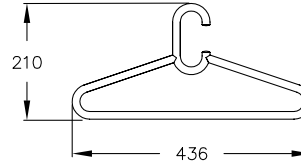

Kleiderbügel Coat hanger

Code PG 2300

- | | | |
|-----------------------|-----------------|---------|
| ▶ NY.KB 78.01 | | |
| 436 x 210 mm | 0338 010 | 15,50 € |
| 436 x 210 mm, Antibac | 4338 010 | 18,25 € |



Garderobenhaken

- 65 x 73 mm,
- aus Nylon, optional mit antibakteriellem Schutz,
- erhältlich in den Nylon-Farben,
- verdeckte Verschraubung,
- Lieferung ohne Schrauben Ø 5 mm und Dübel.

Coat hook

- 65 x 73mm,
- made of Nylon, on request with antibacterial protection,
- available in Nylon colours,
- concealed screw fixing,
- supplied without plugs and screws 5mm dia.

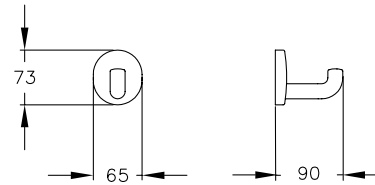

Haken Hook

Code PG 2400

- | | | |
|---------------------|-----------------|---------|
| ▶ NY.GH 78 | | |
| 65 x 73 mm | 0339 010 | 11,00 € |
| 65 x 73 mm, Antibac | 4339 010 | 13,00 € |



Türstopperhaken

- 65 x 73 mm,
- aus Nylon, optional mit antibakteriellem Schutz,
- erhältlich in den Nylon-Farben,
- Puffer aus Polyuretan, Farbe schwarz,
- verdeckte Verschraubung,
- Lieferung ohne Schrauben Ø 5 mm und Dübel.

Doorstop hook

- 65 x 73mm,
- made of Nylon, on request with antibacterial protection,
- available in Nylon colours,
- buffer made of polyurethan, colour black,
- concealed screw fixing,
- supplied without plugs and screws 5mm dia.

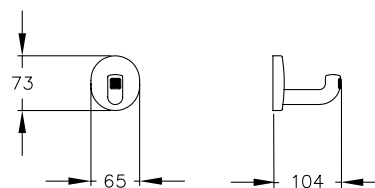

Haken Hook

Code PG 2400

- | | | |
|---------------------|-----------------|---------|
| ▶ NY.TSTH 78 | | |
| 65 x 73 mm | 0340 010 | 14,00 € |
| 65 x 73 mm, Antibac | 4340 010 | 15,25 € |



Haken

- aus Nylon, optional mit antibakteriellem Schutz,
- erhältlich in den Nylon-Farben,
- verdeckte Verschraubung,
- Lieferung ohne Schrauben Ø 4 mm und Dübel.

Coat hook

- made of Nylon, on request with antibacterial protection,
- available in Nylon colours,
- concealed screw fixing,
- supplied without plugs and screws 4mm dia..

Haken Hook

Code PG 2400

- | | | |
|---------------------|-----------------|--------|
| ▶ NY.DH 53 | | |
| 28 x 58 mm | 0583 200 | 6,40 € |
| 28 x 58 mm, Antibac | 4583 200 | 7,25 € |

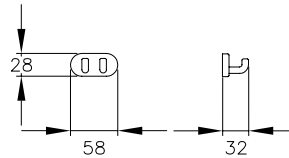

- | | | |
|---------------------|-----------------|--------|
| ▶ NY.WH 55 | | |
| 58 x 28 mm | 0583 100 | 4,25 € |
| 58 x 28 mm, Antibac | 4583 100 | 4,90 € |

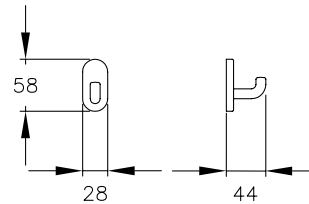

- | | | |
|---------------------|-----------------|--------|
| ▶ NY.WH 57 | | |
| 70 x 34 mm | 0583 110 | 8,45 € |
| 70 x 34 mm, Antibac | 4583 110 | 9,60 € |

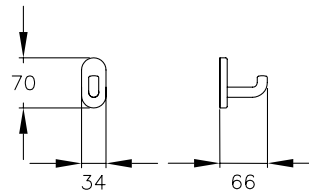

- | | | |
|---------------------|-----------------|---------|
| ▶ NY.WH 58 | | |
| 78 x 38 mm | 0583 120 | 10,50 € |
| 78 x 38 mm, Antibac | 4583 120 | 12,00 € |

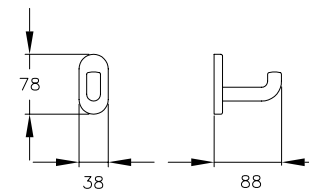



Wandhaken

- aus Nylon, optional mit antibakteriellem Schutz,
- erhältlich in den Nylon-Farben,
- verdeckte Verschraubung.

Hook

- made of Nylon, on request with antibacterial protection,
- available in Nylon colours,
- concealed screw fixing.

① Lieferung ohne Schrauben Ø 4 mm und Dübel (0305 000/4305 000).
Lieferung ohne Schrauben Ø 5 mm und Dübel (0305 010/4305 010).

① Supplied without plugs and screws 4mm dia. (0305 000/4305 000).
Supplied without plugs and screws 5mm dia. (0305 010/4305 010).

Wandhaken Hook

Code PG 2400

▶ NY.WH 73 Ø 40 mm	0305 000	4,10 €
Ø 40 mm, Antibac	4305 000	4,50 €
▶ NY.WH 75 58 x 52 mm	0305 010	6,20 €
58 x 52 mm, Antibac	4305 010	7,10 €

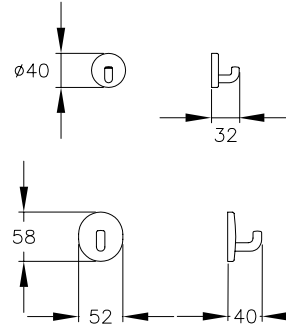

Sicherheitswandhaken

- 58 x 52 mm,
- aus Nylon, optional mit antibakteriellem Schutz,
- erhältlich in den Nylon-Farben,
- verdeckte Verschraubung,
- Lieferung ohne Schrauben Ø 5 mm und Dübel.

Hook

- 58 x 52mm,
- made of Nylon, on request with antibacterial protection,
- available in Nylon colours,
- concealed screw fixing,
- supplied without plugs and screws 5mm dia.

Sicherheitswandhaken Hook

Code PG 2400

▶ NY.SWH 76 58 x 52 mm	0304 010	5,85 €
58 x 52 mm, Antibac	4304 010	6,55 €

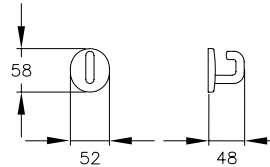

Doppelkleiderhaken

- 91 x 85 mm,
- aus Nylon,
- erhältlich in den Nylon-Farben,
- passend für Garderoben Ø 34 mm.

Double coat hook

- 91 x 85mm,
- made of Nylon,
- available in Nylon colours,
- suitable for 34mm dia. wardrobes.

Doppelkleiderhaken Double coat hook

Code PG 0800

▶ NY.DH 34 91 x 85 mm passend für Garderoben Ø 34 mm suitable for wardrobes 34mm dia.	0362 120	5,85 €
--	-----------------	--------

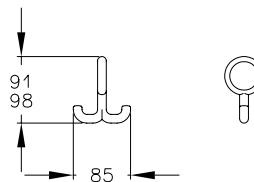



Deckenhaken
Ceiling hook

Code PG 2400

▶ NY.DEH 55 **0583 250** 7,00 €
68 x 34 mm

Für Platten **bis** 10 mm Dicke
min. Schraubenlänge = Plattendicke + 10 mm
max. Schraubenlänge = Plattendicke + 12 mm

For boards **up to** 10mm thickness
min. screw length = board thickness + 10mm
max. screw length = board thickness + 12mm

▶ NY.DEH 55.1 **0583 270** 8,65 €
68 x 34 mm

Für Platten **ab** 10 mm Dicke
min. Schraubenlänge = Plattendicke + 5 mm
max. Schraubenlänge = Plattendicke + 12 mm

For boards **from** 10mm thickness
min. screw length = board thickness + 5 mm
max. screw length = board thickness + 12mm

▶ NY. DEH 55.2 **0583 280** 8,65 €
68 x 34 mm

Deckenhaken

- 68 x 34 mm,
- aus Nylon,
- erhältlich in den Nylon-Farben,
- zur verdeckten Verschraubung von unten mit \varnothing 4 mm Senkschrauben,
- Lieferung ohne Schrauben \varnothing 4 mm und Dübel.

Ceiling hook

- 68 x 34 mm,
- made of Nylon,
- available in Nylon colours,
- concealed screw fixing from below with 4mm dia. countersunk screws,
- supplied without plugs and screws 4mm dia..

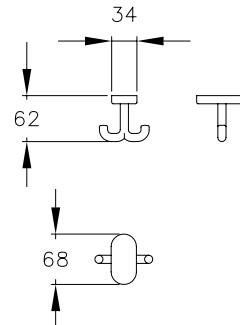

Deckenhaken

- 68 x 34 mm,
- aus Nylon,
- erhältlich in den Nylon-Farben,
- mit Gegenrosetten zur verdeckten Verschraubung von unten in Zapfen \varnothing 7,5 mm,
- Lieferung ohne (Senk-Spax-) Schrauben \varnothing 4 mm.

Ceiling screw

- 68 x 34mm,
- made of Nylon,
- available in Nylon colours,
- with counter roses for concealed screw fixing from below in lugs 7,5mm dia.,
- supplied without countersunk/spax screws 4mm dia..

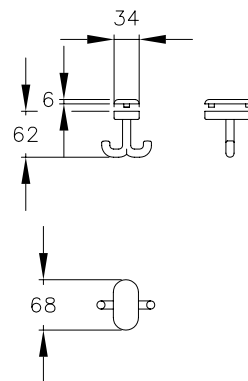

Deckenhaken, drehbar

- 72 mm,
- aus Nylon,
- erhältlich in den Nylon-Farben,
- drehbar,
- verdeckte Verschraubung,
- Lieferung ohne Schrauben \varnothing 4 mm und Dübel.

Ceiling hook, rotating

- 72mm,
- made of Nylon,
- available in Nylon colours,
- rotating,
- concealed screw fixing,
- supplied without plugs and screws 4mm dia..



Deckenhaken
Ceiling hook

Code PG 2400

▶ NY.KH 75 **0148 020** 7,90 €
72 mm

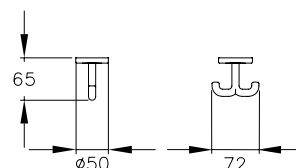



Haken

- aus Nylon,
- erhältlich in den Nylon-Farben,
- verdeckte Verschraubung,
- Lieferung ohne Schrauben Ø 5 mm und Dübel.

Hook

- made of Nylon,
- available in Nylon colours,
- concealed screw fixing,
- supplied without plugs and screws 5mm dia.

Haken Hook

	Code	PG 2400			
▶ NY.HH 84 140 x 45 mm	0584 010	8,65 €			
▶ NY.MH 84 65 x 45 mm	0584 020	4,50 €			
▶ NY.WH 84 65 x 45 mm	0584 050	9,40 €			
▶ NY.GH 84 65 x 45 mm	0584 030	12,50 €			
▶ NY.HH 76 140 x 23 mm	0180 050	8,75 €			
▶ NY.MH 76 70 x 23 mm	0180 040	4,25 €			
▶ NY.MH 82 46 x 20 mm	0522 010	2,50 €			
▶ NY.HH 62 165 x 20 mm	0160 020	7,50 €			
▶ NY.MH 62 62 x 20 mm	0160 010	3,05 €			



Piktogramme

- Höhe 130 mm, Breite ... mm, Symbole: Herren, Damen, Barrierefrei,
- aus Nylon,
- erhältlich in den Nylon-Farben,
- selbstklebend.

Symbol

- height 130mm, width ... mm, symbol: Gentlemen, Ladies, Barrefree,
- made of Nylon,
- available in Nylon colours,
- self-adhesive.

Piktogramme Symbol

Code PG 1500

▶ NY.PCT 1
50 x 130 mm
Herren
Gentlemen symbol

0510 010 10,00 €

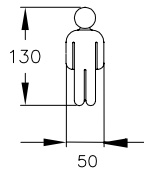

▶ NY.PCT 2
50 x 130 mm
Damen
Ladies symbol

0510 020 10,00 €

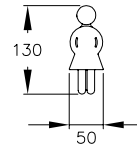

▶ NY.PCT 4
113 x 130 mm
Barrierefrei
Barrefree symbol

0510 040 10,00 €

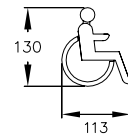

Beschriftungsschild

- 100 x 100 mm,
- aus Nylon,
- erhältlich in den Nylon-Farben,
- Klarsichtabdeckung aus PMMA,
- weiße Folieneinlage 100 x 80 mm,
- selbstklebend.

Card frame

- 100 x 100mm,
- made of Nylon,
- available in Nylon colours,
- PMMA transparent cover,
- white sheet insert 100 x 80 mm,
- self-adhesive.

Beschriftungsschild Card frame

Code PG 0800

▶ 100 x 100 mm

0846 010 17,25 €

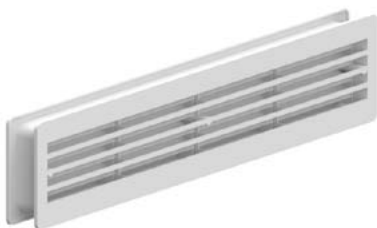
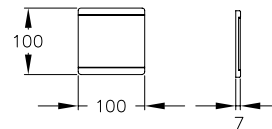

Badezimmerlüftung

- Außenmaß 460 x 92, 295 x 120 mm, Ausschnitt 436 x 76, 276 x 105 mm,
- aus Polystyrol,
- erhältlich in weiß (019),
- für Türstärke 30 - 42 mm,
- Luftdurchlass 165 cm² (0089 010), Luftdurchlass 154 cm² (0087 010),
- Verpackungseinheit 20 Paar,
- Lieferung mit Schrauben für Türstärke 40 mm.

Bathroom ventilator

- outer dimensions 460 x 92, 295 x 120mm, door cut-out 436 x 76, 276 x 105mm,
- made of polystyrene,
- available in white (019),
- for 30 to 42mm door thickness,
- airflow 165cm² (0089 010), airflow 154cm² (0087 010),
- packing unit 20 pairs,
- supplied with screws for 40mm door thickness.

Badezimmerlüftung Bathroom ventilator

Code PG 0500

▶ NY.BZL 77
460 x 92 mm

0089 010 10,25 €

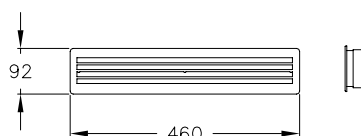

▶ NY.BZL 70
295 x 120 mm

0087 010 10,25 €

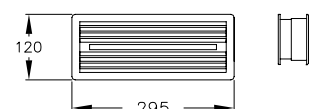

Farbkarte Accessoires / Colour Chart accessories			NCS S RAL-DS RAL	Lichtreflex light reflex	Antibac
Nylon Care					
	019	Wei / White	NCS S 0500-N RAL-DS 000 95 00 RAL 9016	87	
	067	Manhattan	NCS S 2502-Y RAL-DS 080 70 05	58	
	028	Verkehrsgrau / Traffic grey	NCS S 4502-G RAL-DS 000 60 00 RAL 7042	26	
	018	Dunkelgrau / Dark grey	NCS S 7500-N RAL-DS 3500 RAL 7043	14	
	020	Taupe	hnlich NCS S 5010-Y50R; hnlich RAL 1019 similar NCS S 5010-Y50R; similar RAL 1019	24	
	016	Schwarz / Black	NCS S 9000-N RAL-DS 1500 RAL 9005	5	
	022	Gelb / Yellow	NCS S 1080-Y10R RAL-DS 080 80 90	65	
	035	Dunkelrot / Dark red	NCS S 6030-R10B RAL-DS 010 20 25 RAL 3005	6	
	014	Pastellblau / Pastel blue	hnlich NCS S 5020-R90B; hnlich RAL 5007 similar NCS S 5020-R90B; similar RAL 5007	15	
	015	Saphirblau / Sapphire blue	hnlich NCS S 8010-R90B; hnlich RAL 5011 similar NCS S 8010-R90B; similar RAL 5011	7	

de Die jeweils nchstliegenden Farbnummern von NCS (Natural-Colour-System), RAL-DS (RAL-Design-System) und RAL (RAL Farbbregister 841-GL) sind zum Vergleich angegeben.

en For comparison we have indicated the most similar colour numbers of the NCS (Natural-Colour-System), RAL-DS (RAL-Design-System) and RAL (RAL Colour Register 841-GL).

Über Allegion™

Allegion (NYSE: ALLE) ist ein internationaler Anbieter im Bereich Sicherheit mit führenden Marken wie CISA®, Interflex®, LCN®, NORMBAU, Schlage® und Von Duprin®. Mit dem Schwerpunkt auf Sicherheit rund um Türen und Zutritt bietet Allegion ein breites Spektrum an Lösungen für Privathaushalte, Firmen, Schulen und andere Einrichtungen. Allegion erwirtschaftet einen Umsatz von 2 Mrd. US-Dollar und vertreibt seine Produkte in rund 130 Ländern weltweit.

Weitere Informationen unter www.allegion.com

About Allegion™

Allegion (NYSE: ALLE) is a global pioneer in safety and security, with leading brands like CISA®, Interflex®, LCN®, NORMBAU, Schlage® and Von Duprin®. Focusing on security around the door and adjacent areas, Allegion produces a range of solutions for homes, businesses, schools and other institutions. Allegion is a \$2 billion company, with products sold in almost 130 countries.

For more, visit www.allegion.com.

AXA ■ BRICARD ■ Briton ■ CISA ■ interflex ■ KRYPTONITE ■ NORMBAU ■ SimonsVoss technologies ■ TRELOCK



NORMBAU
PASSION FOR CARE
Care Solutions

NORMBAU
Care Solutions

www.normbau.de

Weitere Informationen und **alle technischen Details** unserer Produkte finden Sie auf unserer Website. Hier können Sie direkt die **Care Solutions Broschüre** und den **Care Solutions Katalog** downloaden.

Further information and **all technical details** of our products can be found on our website. Here you can download the **Care Solutions brochure** and the **Care Solutions catalogue**.

Preisliste 2023 - Price list 2023

NORMBAU GmbH
Schwarzwaldstraße 15
77871 Renchen | Germany
Telefon +49 7843 704-0
Telefax +49 7843 704-63
www.normbau.de
normbau@allegion.com

ALLEGION™